

---

ARC FAULT DETECTION DEVICE (AFDD)

## **Maximum safety and easy installation: S-ARC1**

Arc fault detection device  
with integrated MCB



## Maximum safety

### S-ARC1 arc fault detection device with integrated MCB



Comprehensively protect people, irreplaceable goods and buildings – easier, better, safer. Extended fire protection in the electrical installation with S-ARC1.

—  
01 The S-ARC1 reliably protects against arc faults.

Each year all over Europe, over two million fires start due to faults in the electrical installation and these often occur as a result of dangerous arc faults.

#### The best comprehensive protection

An AFDD (Arc Fault Detection Device) according to the product standard "IEC 62606 - General requirements for Arc Fault Detection Devices" is a device intended to mitigate the effects of arcing faults by disconnecting the circuit when an arc fault is detected. This product standard is partially derived from the UL 1699 standard.

S-ARC1 and S-ARC1 M are the new 1P+N arc fault detection devices with integrated miniature circuit breaker (MCB) in 6kA and 10kA breaking capacity respectively: in only two modules width, these devices provide protection against overcurrents and arc faults.

Combined with a Residual Current Circuit Breaker (RCCB) as upstream device, the S-ARC1 series provides the best solution for complete protection in the switchboard, for people, buildings, and irreplaceable goods.



# Protection for people and irreplaceable goods

## Maximum safety in all kinds of applications

The majority of fires in buildings are caused by faults in the electrical installation. These fires are mainly caused by dangerous arc faults. The solution: S-ARC1.

—  
01 Areas of application for the S-ARC1  
Bedrooms and common rooms in nurseries

—  
02 Areas of application for the S-ARC1  
Paper manufacturing plants, printers

S-ARC1 provides maximum safety in all buildings, thus protecting people and valuable assets. By early detecting arc faults and disconnecting the affected circuit the AFDD with integrated MCB offers reliable and complete protection in any type of building.

### Safety in many building types

According to the standard IEC 60364-4-42, an arc fault detection device is strongly recommended in particular applications, as per example:

- **Sleeping and common rooms**
  - in nurseries
  - in senior and care homes
  - in equipment for disabled persons
- **Places and rooms** with existing fire risks and flammable materials, such as for example in production facilities, barns, carpenter workshops, paper manufacturing plants or printing shops where the fire risk is high
- **Places and rooms with prevalingly flammable building materials** like wood houses, flammable buildings or forced ventilation systems
- **Places and rooms with irreplaceable goods (cultural assets)**, such as those in museums, libraries, galleries, archives or architectural monuments

### Recommendation for any room

The use of the AFDD is additionally recommended in any rooms with sleeping facilities in private apartments, houses, hospitals (does not apply in medically used areas) and hotels. This also includes places with a fire-disseminating structure, such as the chimney effect in high-rise buildings or final circuits with high connected load, e.g. dishwashers, washing machines or dryers.



—  
01

—  
02



# Early detection for extended protection against fires

## S-ARC1 closes the protection gap against arc faults

—  
01 Serial arc faults occur when a conductor is disrupted.

—  
02 Parallel arc faults occur between external conductors and protection of neutral conductors.

—  
03 The S-ARC1 detects arc faults against ground.

—  
04 A damaged line and insulation can lead to a fire risk through a serial arc fault.

—  
05 Loose contact in an incorrectly connected flush-mounted outlet can lead to a fire risk through a serial arc fault

—  
06 Scorched faulty installation or terminal connection of a flush-mounted outlet.

The arc fault detection device (AFDD) detects series arc faults (current is flowing within one conductor of the final circuit), parallel arc faults (current is flowing between active conductors in parallel with the load of the circuit) and earth arc faults (current is flowing from active conductor to the earth).

### Disruptions in the electrical installation

Serial arc faults occur when a conductor is disrupted, parallel arc faults in the case of contact between phase and neutral conductors or in the case of contact between phase and protective conductors.

The most frequent causes of the development of arc faults are:

- Damaged insulation, e.g. by screws or nails
- Trapped cables in doors and windows
- Incorrect installation
- Cable breakage due to e.g. bend radii which are too narrow and mounting clips which are too tight
- UV radiation and rodent damage to cables in the outdoor areas
- Loose contacts and connections, for example in poorly installed switches/outlets or multiple sockets
- Snapped plugs and cables, e.g. due to carelessly moved furniture

**Series Arc fault  $\geq 5A$**

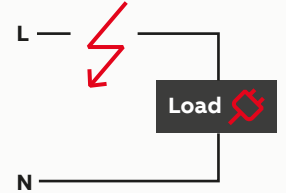

—  
01

**Parallel arc fault  $\geq 75A$**

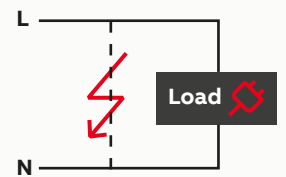

—  
02

**Earth arc fault**

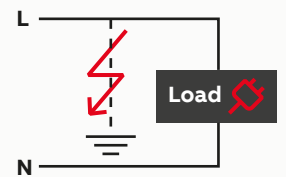

—  
03

—  
04



—  
05



—  
06

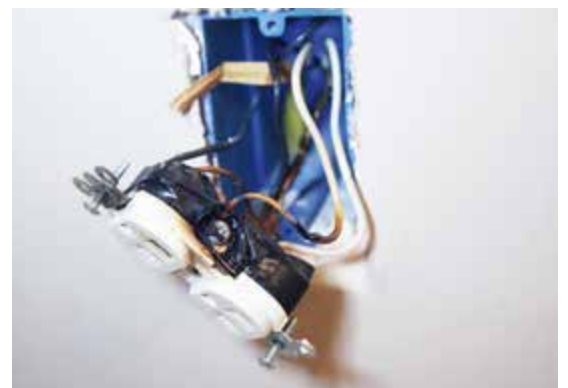



—  
01

—  
01 Security  
in buildings with  
flammable materials

With S-ARC1 many hazards triggered by disruptions in the electrical installation are detected in advance. Thus, the existing gap of protection against arc faults is closed, leading to complete safety in buildings for persons, investments and irreplaceable goods.

The device is also equipped with an overvoltage protection if the voltage is higher than 275V.

**Reliable protection against:**

- Overcurrent (short circuits, overload)
- Earth arc faults
- Parallel arc faults
- Serial arc faults

**Complete safety in the electrical installation**

**01 Circuit breaker (MCB)**

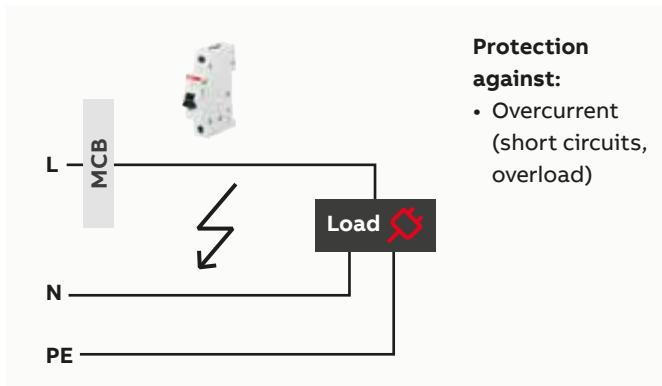

**03 S-ARC1 AFDD with integrated miniature circuit breaker**

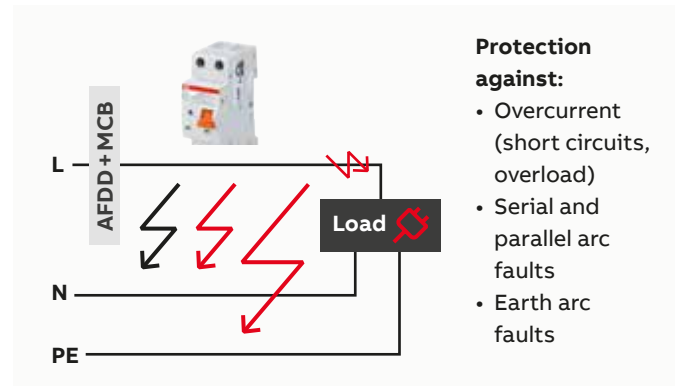

**02 RCD (RCBO)**

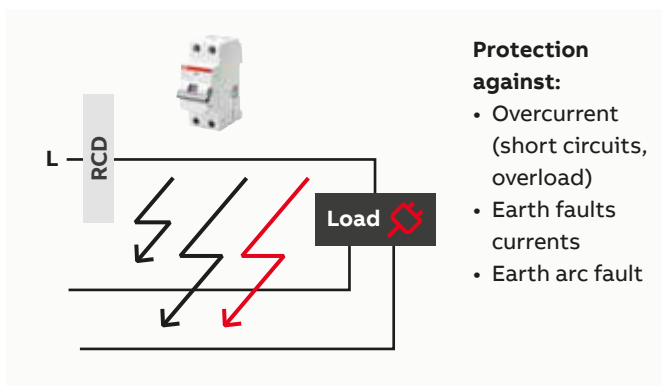

**04 RCD and S-ARC1 AFDD with integrated miniature circuit breaker**

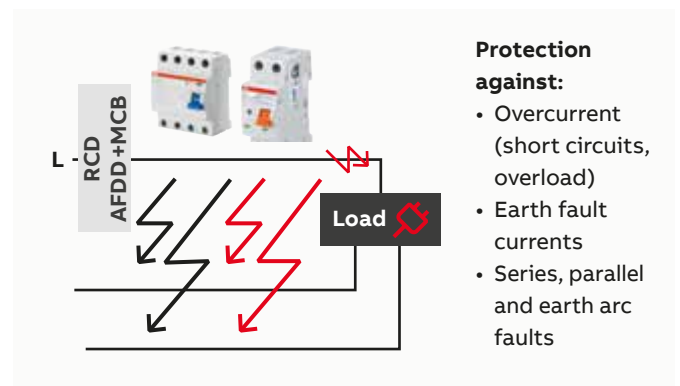

## Easy Installation

Quick and easy wirings without any additional cables

Easy installation and comprehensive protection against serial and parallel arc faults – the S-ARC1 combines everything that is needed for extended fire protection in all types of buildings.

—  
01 Wiring with  
2-pole RCCB

—  
02 Wiring with  
4-pole RCCB

The S-ARC1 series is suitable for installation both with cables and busbars and supply is possible either from top or bottom terminals according to the different countries installation habits. An easy and quick installation is possible with System pro *M compact*® busbars. The product is also compatible with System pro *M compact*® accessories that can be mounted directly on the product in few steps.

**Wiring examples of an upstream RCCB with S-ARC1: direct installation on the busbar in only one step without using any extra cables for the connection**

### Wiring with 2 poles RCCB, for one phase applications (Fig. 01):

- A 2-pole F202 RCCB and a S-ARC1 AFDD with a busbar, e.g. type PS2/12A, for individual final circuits

### Wiring with 4 poles RCCB for three phases applications (Fig. 02):

- A 4-pole F204 RCCB and several S-ARC1 AFDDs with a busbar, e.g. type PS4/58NNA, for larger installations with several rooms, such as nurseries or museums

—  
01

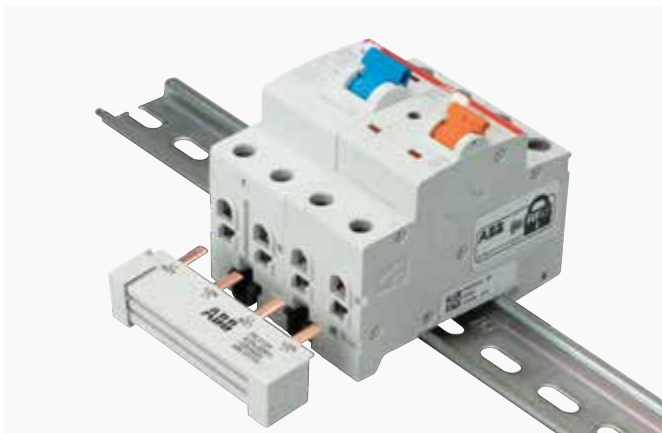

—  
02

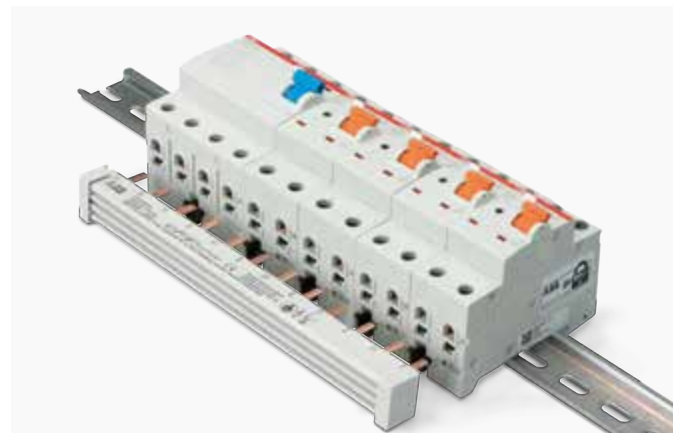

# Reliable protection against arc faults in a proven design

## Unbeatable arguments for the S-ARC1

In only two module width, the S-ARC1 series shares the same profile as the other System pro *M compact*® devices.

01 Connection options of the S-ARC1

02 Areas of application for the S-ARC1 Wooden houses, museums, galleries and architectural monuments

03 Areas of application for the S-ARC1 Workshops for wood processing and carpentry

### Fits perfectly in the System pro *M compact*®

- Phase L left, neutral conductor right
- Combination possible with standard System Pro *M compact*® accessories (auxiliary contact, signal contact, shunt trip, undervoltage/overvoltage releases)
- Supply possible either from top or bottom, S-ARC 1 works in both directions
- Connection possible using cables (up to 25 mm<sup>2</sup>) and busbars (10 mm<sup>2</sup>) thanks to two different terminal slots
- Standard System Pro *M compact*® clip ensures a stable fixing on DIN rail and easy and fast mounting and dismounting operations

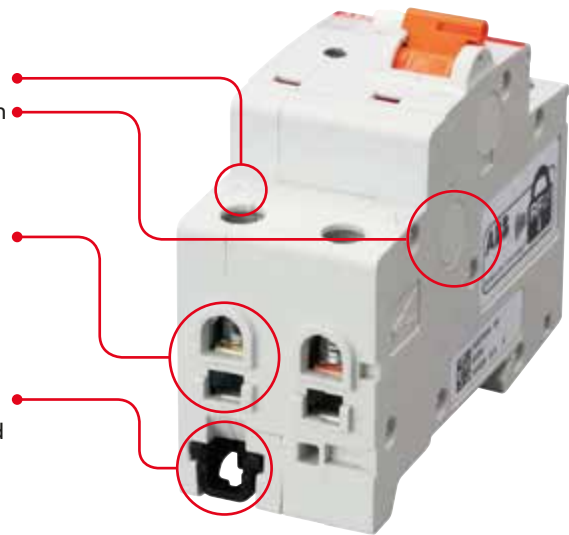

### Your advantages with S-ARC1:

- 100 % flexible power supply from either top or bottom
- Up to 50 % time savings thanks to easy wiring with already existing busbars
- 100 % compatible with System Pro *M compact*® accessories
- Easy wiring thanks to terminals with double slots: 10 mm<sup>2</sup> (busbars) and 25 mm<sup>2</sup> (cables)
- Complete integration in the distribution board with other System Pro *M compact*® devices
- Easy removal from a battery of devices when supplied with busbars

01

02



03



## Best Solution

S-ARC1 product details in the System pro *M* compact® range

### S-ARC1 in overview

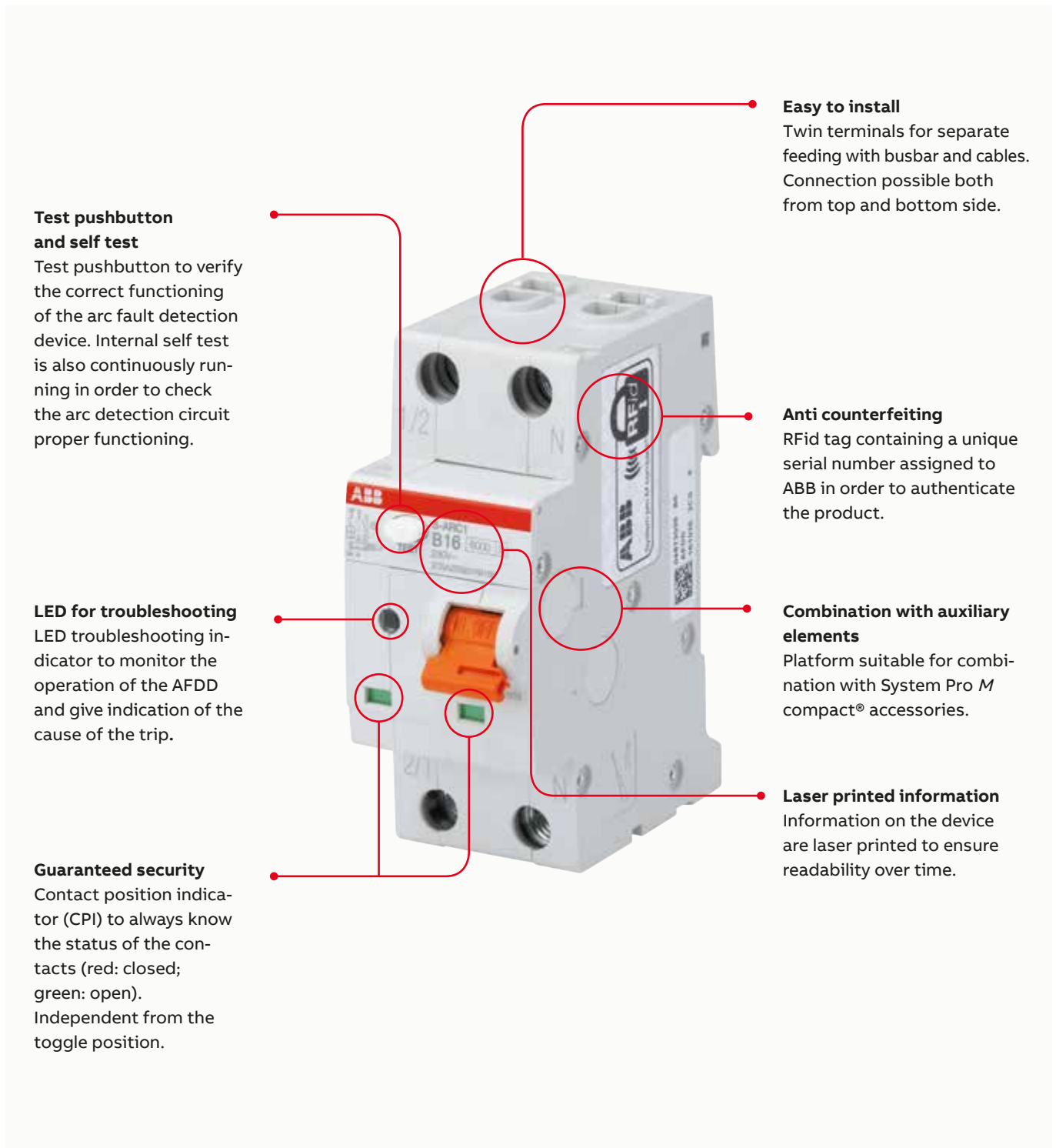



# Reliable technology

## Safe operation and accurate analysis

- 01 The LED function in detail
- 02 LED colors: off, green, red
- 03 Contact position indicator (CPI) in detail

The S-ARC1 series is equipped with LED function monitoring, which shows the current status of the device and identifies the cause of the tripping. Maintenance time can therefore be reduced thanks to an easier troubleshooting of the network. During standard operating mode (toggle in ON position), the LED is green. When the toggle is on OFF position, the LED is OFF.

### Easy fault analysis

In the case of a fault, the LED displays the different fault indications as soon as the toggle has been reclosed.

LED color	blinks/sec.	Signal duration	Cause of the tripping
green	permanent	permanent	manual tripping, test button, overcurrent
red blinking	1	5 secs	serial arc faults
red blinking	2	5 secs	parallel arc faults
red blinking	3	5 secs	overvoltage

After the 5 second blinking the LED turns green again.

### Internal self test

S-ARC1 is also continuously self testing thanks to an internal electronic unit.

If the internal self test fails, the LED can switch off or start blinking green/red alternatively. This is done without any trip, in order to guarantee continuity of service and to avoid unwanted tripping. In this case it is required to press the test button:

- If the device trips, it has recovered to normal behavior and it can be reclosed
- If the device does not trip a replacement is required: call an electrotechnical expert

### Guaranteed security

The contact position indicator (CPI) indicates, in addition to the shift lever, green or red, to identify the real position of the contacts.

- Green: contacts open – regardless of the shift lever position.
- Red: contacts closed



01



02

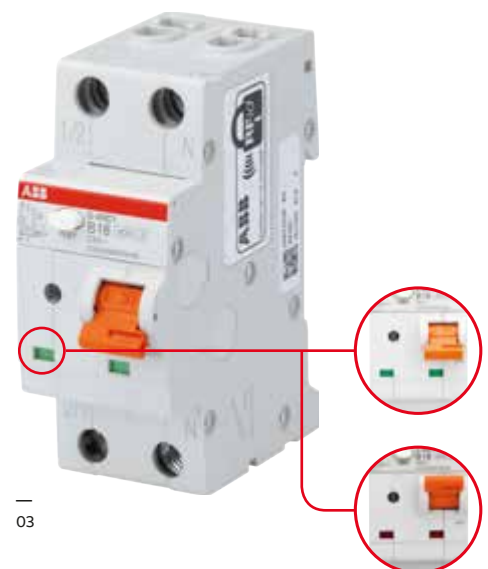

03

## S-ARC1 arc fault detection device with integrated MCB

### Technical data

#### Technical specifications

		S-ARC1	S-ARC1 M	
Standards		IEC/EN 62606; IEC/EN 60898-1	IEC/EN 62606; IEC/EN 60898-1	
<b>Electrical Functions</b>	Number of poles	1P + N	1P + N	
	Rated current $I_n$	A $6 \leq I_n \leq 20$	$6 \leq I_n \leq 20$	
	Rated voltage $U_e$	V 230 - 240	230 - 240	
	Insulation voltage $U_i$	V 500 V AC	500 V AC	
	Overtoltage category	III	III	
	Pollution degree	2	2	
	Min. operating voltage	V 170	170	
	Threshold for protection against overvoltage	V 275	275	
	Rated frequency	Hz 50/60	50/60	
	Rated breaking capacity acc. to IEC 60898-1	ultimate $I_{cn}$	A 6000	10000
		ultimate $I_{cu}$	kA 7.5	10
	Rated breaking capacity acc. to IEC 60947-2	service $I_{cs}$	kA 6	7.5
		Rated residual breaking capacity $I_{cn1}$	A 6000	6000
	Rated impulse withstand voltage (1.2/50) $U_{imp}$	kV 4 (test voltage 6.2kV at sea level; 5kV at 2000 m)	4 (test voltage 6.2kV at sea level; 5kV at 2000 m)	
	Dielectric test voltage at ind. freq. for 1 min.	kV 2 (50/60 Hz, 1 min.)	2 (50/60 Hz, 1 min.)	
	Thermomagnetic release – characteristic	B: $3 I_n \leq I_m \leq 5 I_n$	■	■
		C: $5 I_n \leq I_m \leq 10 I_n$	■	■
Energy limiting class	3	3		
<b>Mechanical Main features</b>	Housing	Insulation group II, RAL 7035	Insulation group II, RAL 7035	
	Toggle	Insulation group IIIA, Orange RAL 2004, sealable in ON-OFF-positions	Insulation group IIIA, Orange RAL 2004, sealable in ON-OFF-positions	
	Contact position indication	Green/red window	Green/red window	
	Electrical life	10000 operations	10000 operations	
	Mechanical life	20000 operations	20000 operations	
	Protection degree acc. to EN 60529	housing	IP4X	IP4X
		terminals	IP2X	IP2X
	Shock resistance acc. to IEC/EN 60068-2-27	30 g - 2 shocks - 13 ms	30 g - 2 shocks - 13 ms	
	Vibration resistance acc. to IEC/EN 60068-2-6	0.35 mm or 5g - 20 cycles at 5...150...5 Hz without load	0.35 mm or 5g - 20 cycles at 5...150...5 Hz without load	
	Environmental conditions (damp heat) acc. to IEC/EN 60068-2-30	°C/ RH 28 cycles with 55°C/90 - 96% and 25°C/95 - 100%	28 cycles with 55°C/90 - 96% and 25°C/95 - 100%	
	Reference temperature for setting of thermal element	°C 30	30	
	Ambient temperature (with daily average $\leq +35$ °C)	°C -25...+55	-25...+55	
	Storage temperature	°C -40...+70	-40...+70	
<b>Assembly</b>	Terminal type	top/bottom	failsafe bi-directional cylinder-lift terminal (shock-protected)	
	Terminal size for cables	top/bottom	mm <sup>2</sup> 25/25	
	Terminal size for busbars	top/bottom	mm <sup>2</sup> 10/10	
	Tightening torque	top/bottom	Nm 2.8	
	Stripping length of the cable		mm 12.5	
	Mounting		on DIN rail EN 60715 (35 mm) by means of mounting clip	
	Mounting position		any	
	Supply from		Top/bottom terminals	
<b>Dimensions and weight</b>	Dimensions (H x D x W)	mm 85 x 69 x 35	85 x 69 x 35	
	Weight	g 180	180	
<b>Combination with auxiliary elements</b>	See next page for details			

## S-ARC1 AFDD with integrated MCB

Order information, accessories, electrical diagrams and dimensions

### Order Information

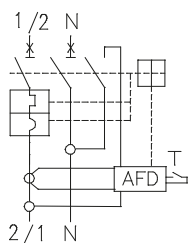

#### S-ARC1, 6kA

Number of poles	Charac-teristics	Rated current I <sub>n</sub> A	Bbn EAN 8012542	Order data Type	Order data Order code	Weight 1 pcs kg	Pkg qty pce
1P+N	B	6	750130	S-ARC1 B6	2CSA255901R9065	0.180	1
		10	178132	S-ARC1 B10	2CSA255901R9105	0.180	1
		13	750031	S-ARC1 B13	2CSA255901R9135	0.180	1
		16	178033	S-ARC1 B16	2CSA255901R9165	0.180	1
		20	749936	S-ARC1 B20	2CSA255901R9205	0.180	1
1P+N	C	6	177937	S-ARC1 C6	2CSA255901R9064	0.180	1
		10	749837	S-ARC1 C10	2CSA255901R9104	0.180	1
		13	500735	S-ARC1 C13	2CSA255901R9134	0.180	1
		16	886136	S-ARC1 C16	2CSA255901R9164	0.180	1
		20	175438	S-ARC1 C20	2CSA255901R9204	0.180	1

#### S-ARC1 M, 10kA

Number of poles	Charac-teristics	Rated current I <sub>n</sub> A	Bbn EAN 8012542	Order data Type	Order data Order code	Weight 1 pcs kg	Pkg qty pce
1P+N	B	6	374312	S-ARC1 M B6	2CSA275901R9065	0.180	1
		10	342113	S-ARC1 M B10	2CSA275901R9105	0.180	1
		13	342014	S-ARC1 M B13	2CSA275901R9135	0.180	1
		16	342212	S-ARC1 M B16	2CSA275901R9165	0.180	1
		20	341215	S-ARC1 M B20	2CSA275901R9205	0.180	1
1P+N	C	6	339816	S-ARC1 M C6	2CSA275901R9064	0.180	1
		10	339717	S-ARC1 M C10	2CSA275901R9104	0.180	1
		13	339618	S-ARC1 M C13	2CSA275901R9134	0.180	1
		16	340416	S-ARC1 M C16	2CSA275901R9164	0.180	1
		20	340317	S-ARC1 M C20	2CSA275901R9204	0.180	1

### Overall dimensions in mm

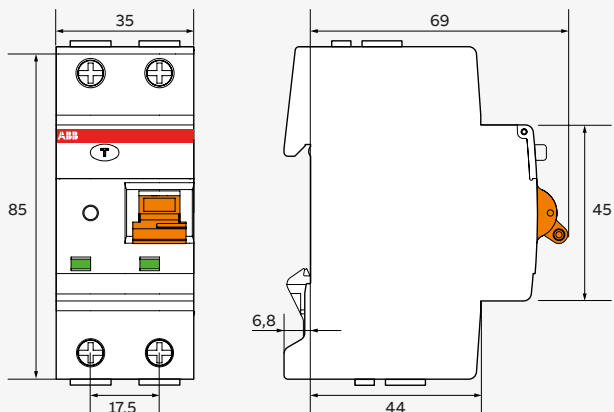

### System pro M compact® accessories – Combinations with accessories

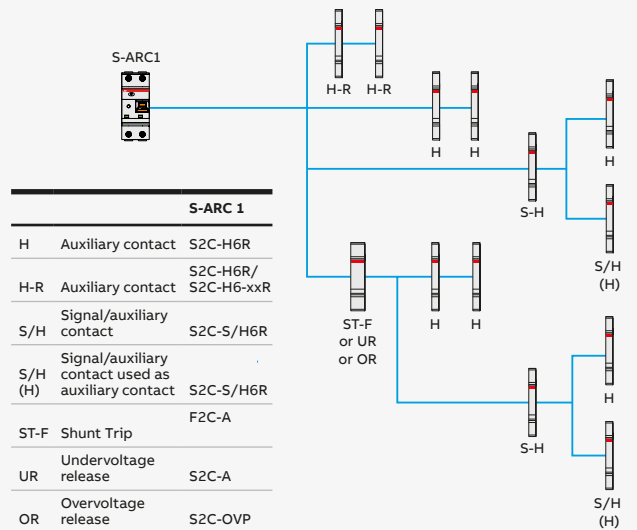

---

**Contact information:**

**ABB S.p.A**

Viale dell'Industria, 18  
20010 Vittuone (MI)  
Phone +39 02 9034 1  
Fax +39 02 9034 7609

**[www.abb.com](http://www.abb.com)**

**Note:**

We reserve the right to make technical changes or modify the contents of this document without prior notice. With regard to purchase orders, the agreed particulars shall prevail. ABB AG does not accept any responsibility whatsoever for potential errors or possible lack of information in this document.

We reserve all rights in this document and in the subject matter and illustrations contained therein. Any reproduction, disclosure to third parties or utilization of its contents – in whole or in parts – is forbidden without prior written consent of ABB AG.

Copyright© 2017 ABB  
All rights reserved

