

---

PRODUCT CATALOG (IEC)

# ABB UPS products and solutions

Power protection for critical infrastructures



# Welcome to ABB's Power Protection catalog

The number of critical applications that simply cannot be allowed to go off line grows daily. These applications must be guaranteed a constant supply of high-quality power.

For customers who need full availability and fuss-free operation, ABB offers a comprehensive portfolio of UPS solutions. ABB's solutions are based on strong and stable architectures that make sure your important application is supported by the very best power protection system, ready to step in and take over at the first sign of trouble.

This product catalogue provides details of ABB's Power Protection solutions and will guide you in choosing which ones are suitable for your needs.

Our uninterruptible power supplies (UPS) and ancillary products cover a wide range of applications and power – from small offices to large data centers. And for each and every user ABB's mission is to provide power protection that ensures the highest availability and the lowest cost of ownership.

Sustainably manufactured in Switzerland to the highest of standards, ABB's Power Protection products employ a variety of technologies – from traditional designs to our leading range of modular products that allow a power protection system to be added to module by module, as and when required. This reduces initial capital outlay and simplifies maintenance.

ABB is always there to provide consultancy so that you can choose the product that is exactly right for you. And afterwards, our global, first-class service organization is at your disposal in more than 100 locations.

Please browse the catalogue to learn more about the ABB Power Protection group, our approach to power protection and details of our products. If you require guidance, we are always ready to assist you in person, or you can visit [www.abb.com/ups](http://www.abb.com/ups).

---

# Table of contents

<b>004–004</b>	<b>About us</b>
<b>005–005</b>	<b>ABB's vision and values</b>
<b>006–007</b>	<b>ABB's UPS manufacturing principles</b>
<b>008–009</b>	<b>ABB's UPS service offering</b>
<b>010–013</b>	<b>ABB's modular UPS design</b>
<b>014–015</b>	<b>Choose the right power protection solution</b>
<b>016–019</b>	<b>DPA UPScale ST (10 - 200 kVA)</b>
<b>020–023</b>	<b>DPA UPScale RI (10 - 80 kVA)</b>
<b>024–027</b>	<b>DPA 250 S4 (50 - 300 kVA)</b>
<b>028–031</b>	<b>DPA 500 (100 - 500 kVA)</b>
<b>032–035</b>	<b>MegaFlex DPA (1000 - 1500 kVA)</b>
<b>036–039</b>	<b>PowerLine DPA (20 - 120 kVA)</b>
<b>040–041</b>	<b>PowerValue 11LI Up (0.6-2 kVA)</b>
<b>042–043</b>	<b>PowerValue 11LI Pro (0.6-2 kVA)</b>
<b>044–047</b>	<b>PowerValue 11T G2 (1-10 kVA)</b>
<b>048–051</b>	<b>PowerValue 11 RT G2 (1-10 kVA)</b>
<b>052–055</b>	<b>PowerValue 11/31 T (10 - 20 kVA)</b>
<b>056–059</b>	<b>PowerScale 33 (10 - 50 kVA)</b>
<b>060–065</b>	<b>PowerWave 33 (60 - 500 kVA)</b>
<b>060–065</b>	<b>TLE Series IEC (200 - 400 kVA)</b>
<b>060–065</b>	<b>SG Series IEC (10 - 500 kVA)</b>
<b>066–066</b>	<b>Xtra VFI</b>
<b>067–067</b>	<b>Tested and trusted</b>
<b>068–071</b>	<b>Battery cabinets and accessories</b>
<b>072–075</b>	<b>Connectivity solutions</b>

# About us



**The ABB Power Protection product group was formed from the combination of the ABB product lines: UPS, Power Solutions and Power Conditioning. These three strands of technology each have their own history and each ultimately has as a background ABB's vast experience in electrical engineering that stretches back over a century.**

From the very start, ABB was a UPS innovator and by 1994 had designed, manufactured and launched its first generation of three-phase, transformerless standalone UPS.

Further innovation followed and the UPS product portfolio grew through several generations to cover three-phase applications and ever-higher powers.

In 1998, the first generation of modular UPSs was introduced. A modular UPS delivers total flexibility and availability as well as a low total cost of ownership. ABB's patented decentralized parallel architecture – DPA, the foundation of the modular approach – has proven to be a runaway success with customers.

Over the past two decades, via organic growth and acquisitions, ABB's UPS offering has become more comprehensive and diverse and now covers most application requirements, especially those of the demanding data center industry.

ABB are at the forefront of power protection technology and the company's UPS portfolio complements the rest of ABB's Power Protection offering to give a unique line-up of UPS, power conditioning and power switching products that deliver end-to-end solutions to all kinds of power quality issues in almost every conceivable commercial and industrial situation. An expanding team of local business units and channel partners complete the line-up to position ABB for further growth in the global UPS and power protection market.

In a world that is becoming ever more competitive, ABB's UPS products make power protection simple, energy-efficient and always available.

# ABB's vision and values

– power and productivity for a better world

**For a company to know its direction of travel and know what it stands for, it has to have visions and values.**

“Power and productivity for a better world” describes what ABB stands for. In power we are a leader in addressing power infrastructure and control needs for utilities, industry, transport and infrastructure. In productivity – ABB is a leader in operational asset effectiveness – we support our customers in achieving high uptime and speed while reducing waste.

“... a better world” refers to our value proposition to decouple economic growth from environmental pollution. Based on our offering and technologies, we are well positioned to enable growth with less relative energy consumption and make the still-needed energy supply cleaner and more sustainable.

Our vision is clear: our daily actions need to be built on the right set of values – and not only for the world of today but also for the world of tomorrow.

Our values can be summarized as five value pairs that are both fundamental and inspirational:

## **Safety and integrity**

This value pair is the bedrock of our organization. We do not accept business if it means putting people at risk or engaging in unethical practices. At ABB, we take care of ourselves and we look out for our colleagues.

## **Customer focus and quality**

The customer has to be at the center of all our activities – and when we reach them we need to deliver with utmost quality in everything we do. Knowing our customers better, being perceived as having a clear focus on them and providing high-quality offerings and services will make us the partner of choice.

## **Innovation and speed**

Innovation is at the core of our value proposition and will continue to be critical in strengthening and enhancing our competitive position – in daily business, and as we expand our offering towards engineering / consulting, software and value-added services. Speed is essential in everything we do – being efficient with a high quality and without haste is the art that we are committed to mastering.

## **Ownership and performance**

Strengthening clear lines of responsibility and accountability across our organization is a key part of our Next Level strategy. Institutional and individual performance are key to continue to not only survive but succeed in a demanding world. Performance is what is expected from all of us every day – not only continuing what we are doing, but also taking a step forward.

## **Collaboration and trust**

ABB's future, its enhanced competitive strength, must be built around better, more natural collaboration aimed at providing superior customer value. The organization, with undiluted business line responsibilities and empowerment closer to the customer, enables the business, regional / country and functional leaders to collaborate more and more efficiently.



# ABB's UPS manufacturing principles

In ABB, quality is an integral part of our business ethos. Quality guides our actions to ensure we meet our responsibilities and obligations to our customers, our employees, our partners, our suppliers and to our shareholders.

## ABB's commitment to deliver high quality

- Deliver on-time and on-quality products, systems and services that meet or exceed our customers' expectations.
- Identify and understand our customer's expectations, measure customer perceptions and implement improvements to increase customer satisfaction.
- Enable and engage our employees at all levels in a relentless drive to improve operational performance along the value chain from suppliers to customers.
- Increase the motivation and skills of our employees to add value to our customers and our businesses through continual training and development.
- Leverage our partners' and suppliers' strengths to improve our products and our businesses from product design through production, installation and operation.
- Embed social responsibility and company ethics policies in our business practices.
- Continually improve environmental, health and safety performance through all products, operations, systems and services.

## Manufacturing

Quality in manufacturing begins with the order from the customer. We practice made-to-order manufacturing – a lean approach that exploits just-in-time supply and that treats each and every customer order as a single, valuable entity. Each product is individually tested before leaving the factory with a 100 percent pretest on modules individually and a 100 percent final test on modular and standalone UPSs.

## Quality only becomes quality when it is measured and for this reason we employ key performance indicators (KPIs) some of which are:

- Safety
- Quality from the suppliers (part-per-million defect rates and on-time delivery)
- Quantity of products / items produced for new business and for service departments (after sales)
- Internal first-pass yield
- On-time delivery of the finished product



### Product quality assurance

In ABB, we believe in getting it right the first time – and keeping it that way. For that reason, we engage in component homologation as well as the identification of critical components. Suppliers are fully vetted and qualified, on an ongoing basis, and our test verification plan and type testing assures our quality standards even further.

The ABB product development gate model is deployed all the way through to product launch – from initial conception through development to final full release, and after – right up to gate seven. The gate model involves every part of the organization and this ensures that every aspect of the new product is covered, guaranteeing the very best quality.

Should non-conformities arise, ABB has a comprehensive set of monitoring tools with which to examine the issue. This is backed up by a three-level support model:

- **Level 1:** solving problems in the field
- **Level 2:** statistical analysis and mitigation action definition
- **Level 3:** root cause analysis

### Environmentally friendly

ABB has stated policies that drive the company to be as environmentally friendly as possible. One example of this is our product test bay used for all UPS final testing, which features an energy recovery system. This so-called GREEN (Generating Recycled Ecological Energy Network) test bay is a facility that recycles the greater part of the energy used during a UPS test. Only nine percent of the energy used is from the mains; 91 percent is recovered energy. This re-use is far more beneficial than having a traditional resistor load that merely turns the energy into heat, thus wasting it.

Further, the modern ABB building has an efficient heating / cooling system (energy management) as well as strict rules for recycling and managing discards.

### Certification

Product certification

- Accredited third-party certification:

	UPS standards	Low-voltage devices standards
Safety	IEC / EN 62040-1	IEC / EN 60950-1
EMC	IEC / EN 62040-2	IEC / EN 61000-6-2 IEC / EN 61000-6-4 IEC / EN 61000-4-2 IEC / EN 61000-4-3 IEC / EN 61000-4-4 IEC / EN 61000-4-5 IEC / EN 61000-4-6
Performance	IEC / EN 62040-3	
Environmental aspects	IEC / EN 62040-4	

### Factory certification

- ISO 9001 and 14001
- OHSAS18001

# ABB's UPS service offering



A truly global service organization. ABB is at your service worldwide. UPS service experts support customers around the world from more than 100 locations.

## ● Our service network

**Good customer service is the lifeblood of any business or organization. This fact is well understood by ABB and is the fundamental reason why good customer service is driven by ABB management and is of equal importance for all staff.**

ABB's service footprint for the UPS product line is global and is provided by ABB itself or by members of ABB's partner network. All ABB and partner service engineers go through intense product-specific training before they are allowed to carry out service work at a customer site.

Customers can contact their local ABB representative or the nominated ABB partner for assistance. A local field service engineer will help the customer to solve the issue, either by phone or by going on-site. If the field service engineer is in need of assistance, they are able to contact the round-the-clock, 24 x 365 ABB support line in Switzerland. The support line expert assists the local field service engineer in solving the issue by phone and electronic ticketing system as well as local intervention when required. The support team experts are always on duty and will return any call at any time.





During this whole process, the support line expert will be the only point of contact for the local service engineers. This ensures consistency and constant improvement of service, and that the customer is kept fully informed. This level of customer care is a key aspect of ABB's service concept and ensures an increase of competence on all levels. ABB or partner service personnel will often be on-site – for regular maintenance management, on-site commissioning and start-up, product care and so on. They are also available to provide training, and to deliver technical information and documentation.

Factory acceptance tests (FATs) are also a key responsibility for ABB service – standard FATs, special FATs on customer request, FAT management and reports, and associated logistics coordination are all part of this activity. ABB is fully committed to providing top-quality service to ensure that the customer enjoys the very best performance from their ABB products and can use them with full integrity and safety.

# ABB's modular UPS design

## Ensuring high availability and best-in-class power technology

—  
01 In DPA, each UPS module has all the hardware and software it needs for autonomous operation.

### ABB's approach to modular power protection

Despite all the precautions taken during the design and operation of data centers and related control processes, situations can arise in which external power is compromised – either in terms of quality or availability. Such events could result in data loss, nonavailability of essential services, risk to hardware and very high financial losses. This makes a highly dependable UPS mission-critical. Therefore, the most critical loads should be protected by the very best UPS design – Decentralized Parallel Architecture (DPA™).

ABB, a pioneer and leader in large, modular UPSs, provides a full range of modular DPA power protection products as well a standalone solutions. In the following four pages, we will focus on our approach to modular power protection and describe how these modular solutions can help ensure a supply of clean, reliable power to the customer's application.

### DPA architecture

Key benefits

- Distributed control and power
- No single point of failure
- Independent online swappable modules

In DPA, each UPS module contains all the hardware and software required for full UPS system operation. Modules share no common components and each module is a fully functional UPS, so a DPA parallel system offers extremely high system reliability and uptime is maximized. UPS modules can be paralleled to provide redundancy or to increase the system's total capacity.

Some modular UPS systems with a centralized parallel architecture (CPA) have centralized control or hardware. This renders them very vulnerable should a fault occur on one of these centralized components; one fault can bring down the entire UPS system.

With DPA, on the other hand, the UPS is modularized and each module has all the hardware and software needed for autonomous operation – rectifier, inverter, battery converter, static bypass switch, back-feed protection, control logic, display, and mimic diagram for monitoring and control. With all the critical components duplicated and distributed between individual units, potential single points of failure are eliminated. In the unlikely event of one UPS module failing, the failed module will be automatically isolated and the overall system will continue to operate normally.

### Modular UPS with no common components (Decentralized Parallel Architecture)

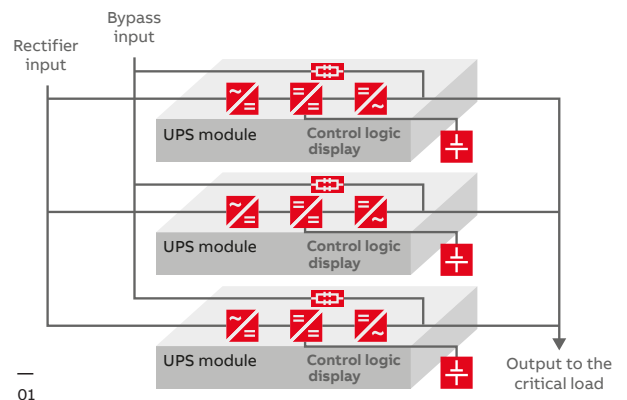

—  
 01 Vertical scalability:  
 one to five modules in  
 one single cabinet.  
 Horizontal scalability:  
 cabinets in parallel  
 configuration up to 3MW

### Online swappable modules (OSM)

#### Key benefits

- Replace or add modules with no downtime
- Simple power upgrade
- No downtime during maintenance

True “online-swap” modularity enables the safe removal and insertion of UPS modules without risk to the critical load and without the need to either transfer it onto raw mains or remove power from it. Modules can therefore be replaced or added without any system downtime. It is simple to upgrade power capability as critical load power requirements grow. Additionally, modules can easily be removed for service or replaced if faulty, without compromising the availability of the system. Only a truly redundant architecture like DPA allows online modules to be swapped out while the system is running.

This unique aspect of modularity directly addresses continuous uptime requirements, significantly reduces mean time to repair (MTTR), reduces inventory levels of spare parts and simplifies system upgrades. This approach pays off too when it comes to serviceability and availability, as there is no downtime and the service personnel do not need special skills.

### Scalability

#### Key benefits

- Vertical and horizontal scalability
- Cost-effective “rightsizing”
- Easy configuration and reconfiguration

The ability to scale the system means the UPS can be sized exactly to fit prevailing needs and modules can simply be added as requirements grow. This means that you only power, cable and cool what you need.

The Conceptpower DPA 500, for example, allows five 100kW modules to be mounted in one cabinet and six cabinets to be configured in parallel to provide a top rating of 3MW. Power consumption is the topic of greatest concern for data center operators and the energy savings made by this modular approach over the service life time of the UPS are substantial. Human error is reduced too: Because things are so simple, wiring errors are eliminated, and configuration and reconfiguration are child’s play.

### Scalability up to 3MW



## ABB's modular UPS design

### Ensuring high availability and low total cost of ownership

#### Availability

##### Key benefits

- 99.9999% (6 nines) availability

By combining the benefits of Decentralized Parallel Architecture, parallel redundancy and online swap modularity, ABB's UPSs have a high mean time between failure (MTBF) and a low mean time to repair (MTTR). This delivers six nines availability – a highly desirable quality required by data centers in pursuit of zero downtime.

The surest way to increase availability of power is to introduce redundancy to the UPS system and to minimize its maintenance and repair time. MTBF and MTTR are common parameters in the UPS industry and both impact system availability. Availability is formally defined as:  

$$\text{MTBF} / (\text{MTBF} + \text{MTTR}) \times 100\%$$

The modular DPA concept allows the modules to work as one system but without interdependence. Quick and simple repair by swapping modules, which can be held as spares on-site or at a nearby service center, minimizes the system's MTTR.

#### Low total cost of ownership

##### Key benefits

- Over 97% true online efficiency
- Eco-mode efficiency  $\geq 99\%$
- Cost-effective scalability to "right size" system
- Low service costs

The modularity and scalability described help minimize the cost of ownership, but costs are held down too by implementing designs that have best-in-class energy efficiency.

ABB's DPA 250 S4, for example, operates with an efficiency of over 97 percent. Its efficiency curve is very flat so there are significant savings in every working regime. Further energy savings can be made by operating the UPS in eco-mode, which increases the efficiency to  $\geq 99$  percent.

#### Online double conversion efficiency

##### Efficiency

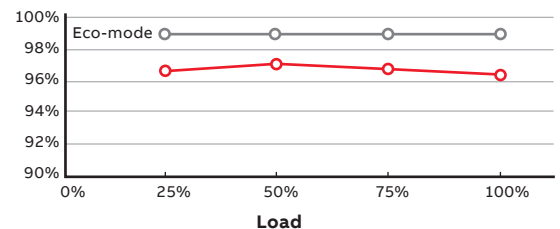

— 01 Example of a changing (increasing) load up to 120kW in 4 years.

— 02 Vertical modularity minimizes space requirements and maximizes predictability of future space requirements. In the example shown, 2m<sup>2</sup> is saved.

**The UPS capacity can be changed with changing load, eliminating the need to oversize the UPS upfront.**

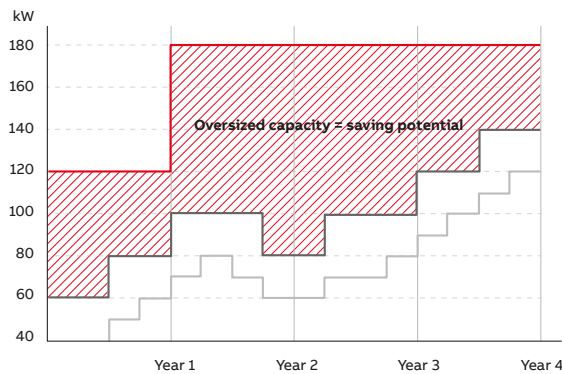

**Standalone solution**  
 2 × 60 kW (N+1) UPS until year 1  
 3 × 60 kW (N+1) UPS years 1–4

/// Oversized capacity

**Modular solution**  
 20kW UPS modules can be added or removed at any time according to the actual need.

— Typical 4-year-load curve of a medium-sized data center

— 01

Modularity lends itself well to keeping UPS footprint small, too – ideal for data centers, where real estate can be restricted and expensive. A modular UPS rack has a small footprint and when extra modules are added, no extra floor space is taken up.

But the advantages of DPA modularity go further as installation and servicing costs are also kept low: A straightforward modular concept simplifies and speeds every step of the deployment process – from planning, through installation and commissioning to full use. DPA modularity also reduces costs as service engineers need less training and spend less time on-site, and any risks of data or production loss are minimized. Inventory levels of spare parts are reduced.

Highly dependable UPSs are mission-critical for many parts of industry. DPA delivers unmatched UPS availability and serviceability, scalability, flexibility and low energy usage.

There are no better UPS architectures available to those users whose critical electrical loads represent a valuable commercial asset that must be kept powered at all costs.

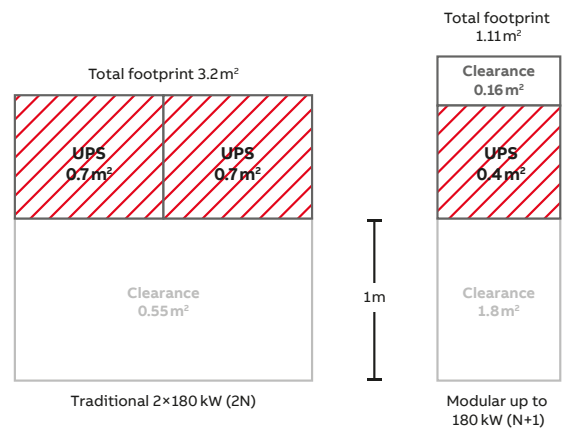

— 02

# Choose the right power protection solution

At the core of our business is a technically advanced product portfolio of high-quality and reliable three-phase and single-phase transformerless uninterruptible power supplies. All our UPSs provide online double conversion topology and are

designed for continuous power protection of critical equipment against all power problems: power failure, power sag, power surge, undervoltage, overvoltage, switching transient, line noise, frequency variation and harmonic distortion.

## ABB's modular UPSs

### UPS cabinet rated power

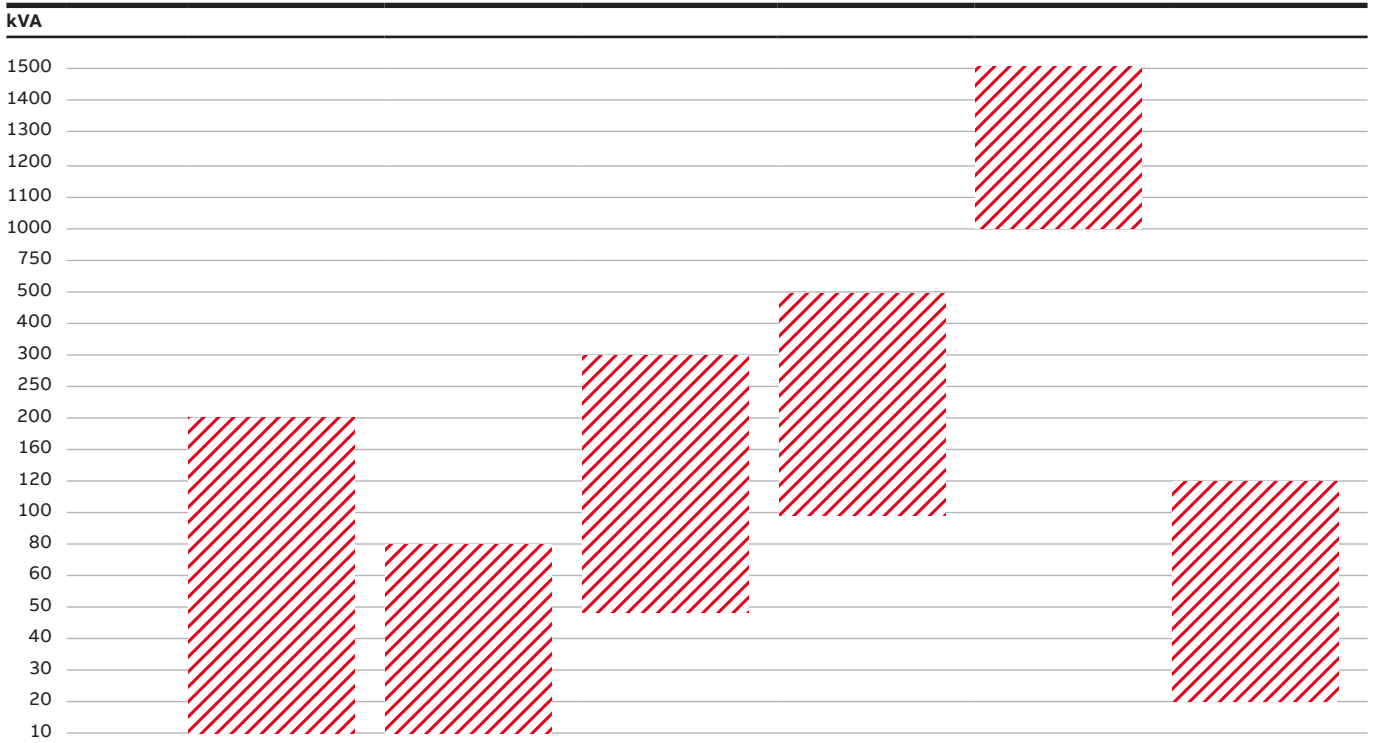

Product	DPA UPScale ST	DPA UPScale RI	DPA 250 S4	Conceptpower DPA500	MegaFlex DPA	PowerLine DPA
<b>Parallelable</b>	Up to 20 modules	–	Up to 5 units	Up to 6 units	Up to 24 modules	Up to 30 modules
<b>System power</b>	400kW	80kW	1500 kW	3000kW	6000 kW	120kVA
<b>Application</b>	Network, server and storage	Network, server and storage	Data center and facility	Data center and facility	Data center and health care	Industrial applications
<b>UPS type</b>	Three-phase modular UPS	Three-phase modular UPS (rack-independent)	Three-phase modular UPS	Three-phase modular UPS	Three-phase modular UPS	Three-phase and single-phase modular UPS

**ABB's standalone UPSs**  
**UPS cabinet rated power**

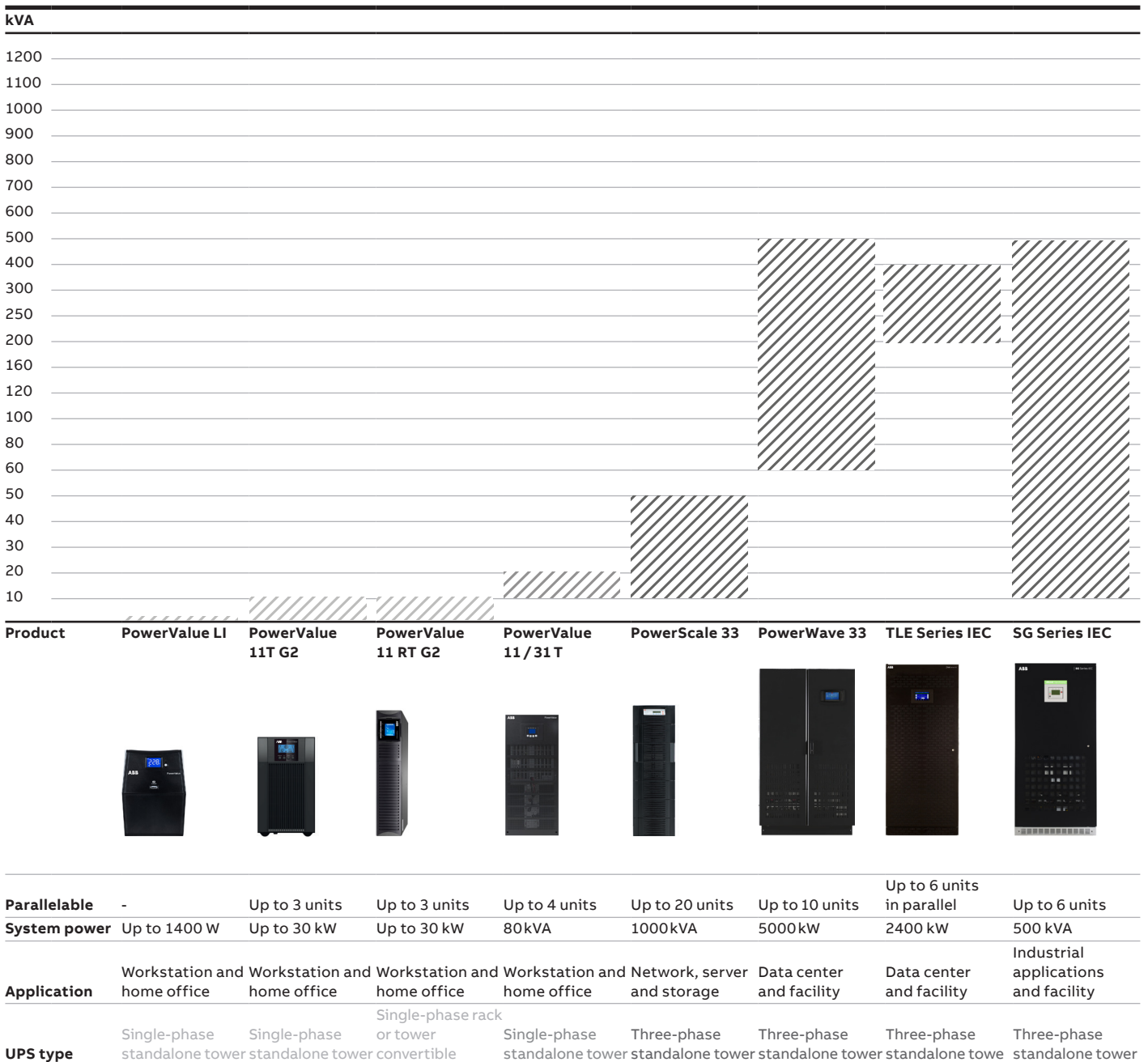

# DPA UPScale ST

The modular UPS designed for low and medium power applications

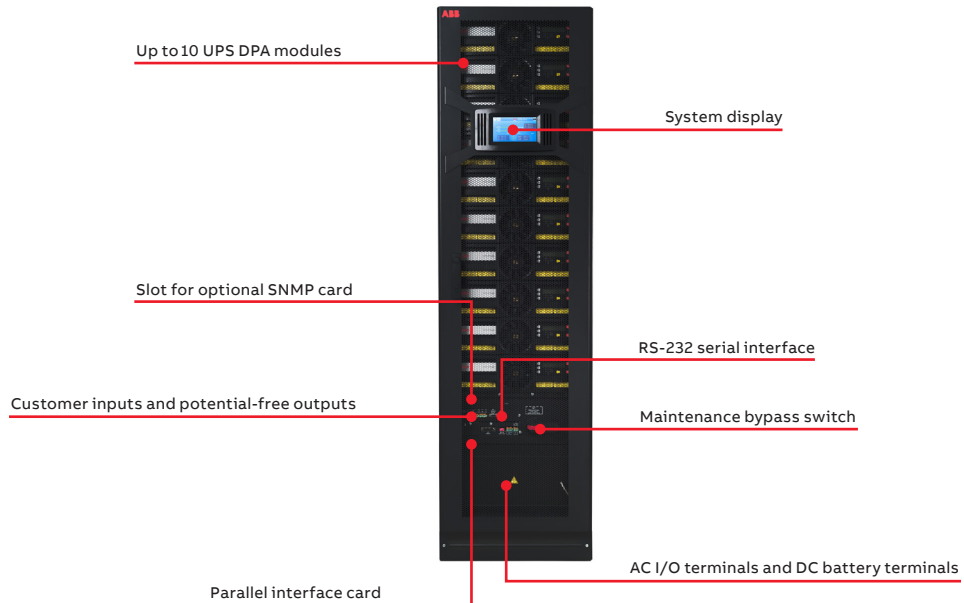

ABB's DPA UPScale ST is available for high density applications requiring an all-in-one power protection solution that includes frame, UPS, battery and communications. The solution delivers power protection from 10kW to 200kW in 10kW or 20kW modular steps. For a

continuously growing mid-sized infrastructure, DPA UPScale ST can be paralleled horizontally to increase the capacity up to 400kW. This fully scalable and easily maintained UPS gives you unparalleled uptime and energy efficiency.

## 99.9999% (6 nines) availability

- Decentralized Parallel Architecture
- No single points of failure
- Redundant capacity (N+1) per frame
- Replace or add modules with no downtime
- Short mean time to repair

## Low total cost of ownership

- Up to 96% true online efficiency
- Eco-mode efficiency  $\geq 98\%$
- Unity power factor (kW = kVA)
- Low input harmonic distortion (THDi <3%)
- Small footprint /high power density (472kW/m<sup>2</sup>)

## All-in-one solution

- Power range from 10kW to 200kW in a single frame
- Internal batteries for short autonomies and external battery cabinets for long autonomies
- User-friendly interface per module and system level
- Remote control and monitoring options available

## Efficient service concept

- Simple power upgrade
- Fast maintenance
- Full front access
- Reduced spare parts needed



# DPA UPScale ST

## Product features

### Full vertical and horizontal scalability

The DPA UPScale ST's modular design provides a vertical scalable power system from 10 kW up to 200 kW (180 kW N+1) in a single cabinet in 10 kW or 20 kW modular steps. For a continuously growing mid-size infrastructure, the DPA UPScale ST system can be paralleled horizontally to increase the capacity up to 400 kW. The ability to increment the power as the critical load grows optimizes the operating efficiency and reduce the initial cost for installations.

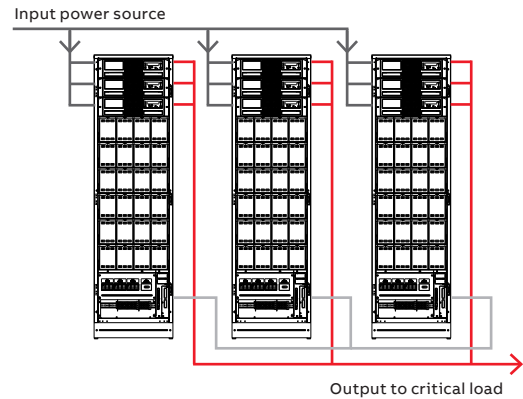

Cabinet type	ST40	ST60	ST80	ST120	ST200
Number of modules per cabinet	1 to 2	1 to 3	1 to 4	1 to 6	1 to 10
Parallel frames per system	4	4	4	3	2
Max. number of modules per system	8	12	16	18	20
Max. total system capacity w/o redundancy	160 kW	240 kW	320 kW	360 kW	400 kW

### The ideal solution for small- to medium-sized critical power IT applications

The DPA UPScale ST can be deployed in a variety of small- to medium-sized system architectures. In addition to traditional server load applications, the DPA UPScale ST is ideal to protect critical applications such as building management systems (BMS). Large facilities are often provided with BMS to control and monitor the building's mechanical and electrical systems such as ventilation, lighting, fire alarms and security.

The BMS is designed to create and maintain a safe, productive and comfortable environment, thus increasing operational efficiency, decreasing the energy consumption and ensuring the safety of personnel and equipment.

The DPA UPScale ST offers clean backup power for sensitive electronic devices (controllers, I/O devices and user interfaces) designed to monitor and control the infrastructure thus avoiding loss of data or damage to equipment.

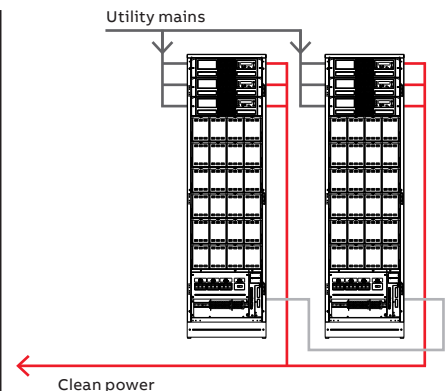
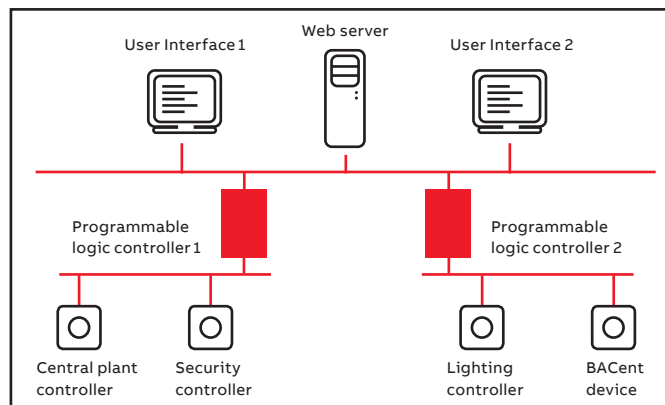

# DPA UPScale ST

## Available models

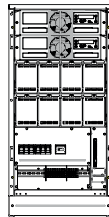

Cabinet type	ST40	ST60
Number of modules	1 to 2	1 to 3
Dimension w × h × d	549 x 1133 x 773 mm	549 x 1976 x 774 mm
Internal battery capacity	Up to 80 blocks 7 / 9Ah	Up to 240 blocks 7 / 9Ah

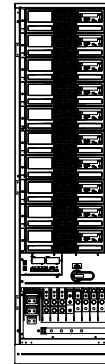
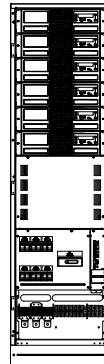
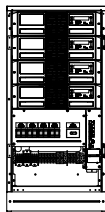

Cabinet type	ST80	ST120	ST200
Number of modules	1 to 4	1 to 6	1 to 10
Dimension w × h × d	549 x 1133 x 773 mm	549 x 1976 x 774 mm	549 x 1976 x 767 mm
Internal battery capacity	–	–	–

### UPS cabinet configuration

- Up to ten online double conversion UPS modules
- LCD control panel per module
- Input, bypass and battery protection fuses
- Manual bypass switch
- Single- and dual-input feed available
- Free space to place internal batteries (only ST40 / ST60)

### Options

- Parallel system configuration
- Integrated back-feed protection
- Cold start
- Halogen-free cabling
- Internal batteries (only ST40 / ST60)
- Battery temperature sensor
- Remote panel (graphical touch screen display)
- System display (graphical touch screen display)
- Control and monitoring (ModBus RS-485, ModBus TCP/IP, SNMP)
- External battery cabinets

# DPA UPScale ST

## Technical specification

General data	ST40	ST60	ST80	ST120	ST200
System power range	10–400kW				
Nominal power per module	10kW / 20kW				
Nominal power / frame	40kW	60kW	80kW	120kW	200kW
Number of UPS modules	1 to 2	1 to 3	1 to 4	1 to 6	1 to 10
Max. number of inbuilt batteries (7 / 9Ah)	80	240	–	–	–
Output power factor	1.0				
Topology	Online double conversion				
Parallel configuration	Up to 20 modules (up to 4 frames)				
UPS type	Modular (Decentralized Parallel Architecture)				
<b>Input</b>					
Nominal input voltage	3×380/220V+N, 3×400/230V+N, 3×415/240V+N				
Voltage tolerance (referred to 3×400/230V)	For loads <100% (–20%, +15%), <80% (–25%, +15%), <60% (–35%, +15%)				
Input distortion THDi	≤3%				
Frequency	35–70Hz				
Power factor	0.99				
<b>Output</b>					
Rated output voltage	3×380/220V+N, 3×400/230V+N, 3×415/240V+N				
Voltage distortion (referred to 3×400/230V)	<1.5%				
Frequency	50Hz or 60Hz				
Overload capability	1 min.: up to 150% / 10 min.: up to 125%				
Unbalanced load	100% (all three phases regulated independently)				
Crest factor	3:1 (load supported)				
<b>Efficiency</b>					
Overall efficiency	Up to 96%				
In eco-mode configuration	98%				
<b>Environment</b>					
Storage temperature	–25 °C to +70 °C				
Operating temperature	0 °C to +40 °C				
Altitude configuration	1000m without derating				
<b>Communications</b>					
LCD	Yes (per module); system display optional (graphical touch screen display)				
LEDs	LED for notification and alarm				
Communication ports	USB, RS-232, SNMP slot, potential-free contacts				
<b>Standards</b>					
Safety	IEC / EN 62040-1				
Electromagnetic compatibility (EMC)	IEC / EN 62040-2				
Performance	IEC / EN 62040-3				
Product certification	CE				
Manufacturing	ISO 9001:2015, ISO 14001:2015, OHSAS18001				
<b>Weight, dimensions</b>					
Weight (with modules / without batteries)	Up to 135kg	Up to 238kg	Up to 168kg	Up to 262kg	Up to 389kg
Dimensions w × h × d (mm)	549 x 1133 x 773	549 x 1976 x 774	549 x 1133 x 773	549 x 1976 x 774	549 x 1976 x 767

# DPA UPScale RI (rack-independent)

The modular UPS for customized power protection solutions

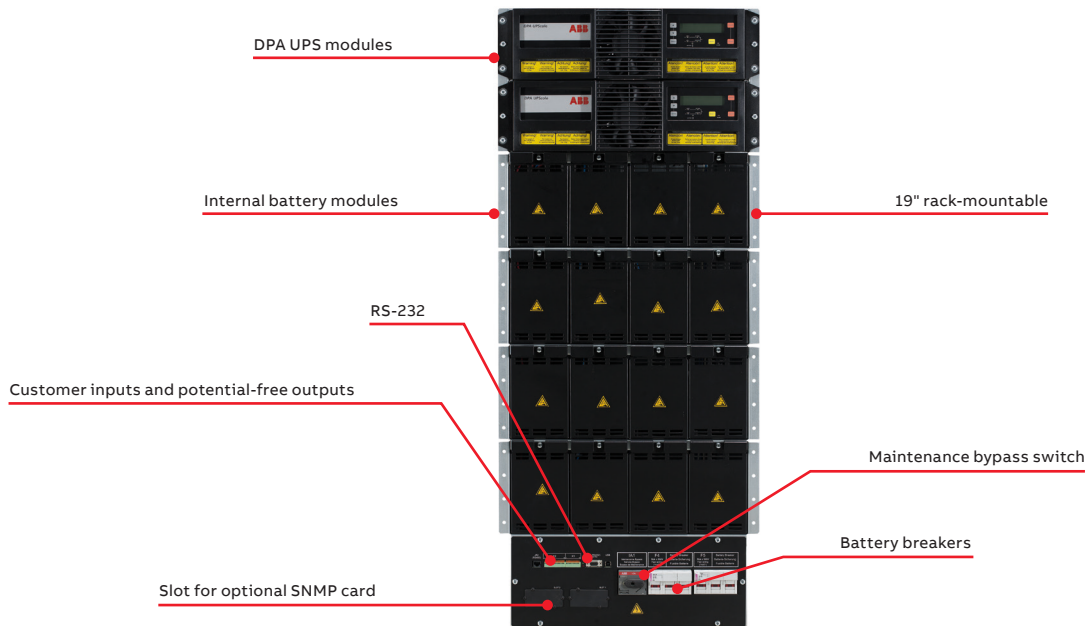

The rack-independent DPA UPScale RI is one of the most compact UPS systems on the market that is suitable for custom-designed solutions. Being modular and rack-mountable, it provides an ideal system from the technical and commercial point of view for when a flexible solution is

required. The DPA UPScale RI, including UPS, battery and communication, can be integrated into any 19" rack (independent of manufacturer) and provides up to 80 kW (60 kW N+1) making it ideal for integrated IT, telecom or other critical control processes.

#### 99.9999% (6 nines) availability

- Decentralized Parallel Architecture
- Replace or add modules with no downtime
- Short mean time to repair
- No single points of failure

#### Low total cost of ownership

- Up to 96% true online efficiency
- Eco-mode efficiency  $\geq 98\%$
- No single points of failure
- Small footprint / high power density
- Unity power factor (kW = kVA)
- Low input harmonic distortion (THDi <3%)

#### Easy customization

- Rack-independent
- Efficient manufacture of individual solutions with standard products
- High local added value for system integrators

#### Efficient service concept

- Simple power upgrade
- Fast maintenance
- Reduced spare parts needed

# DPA UPScale RI

## Available models

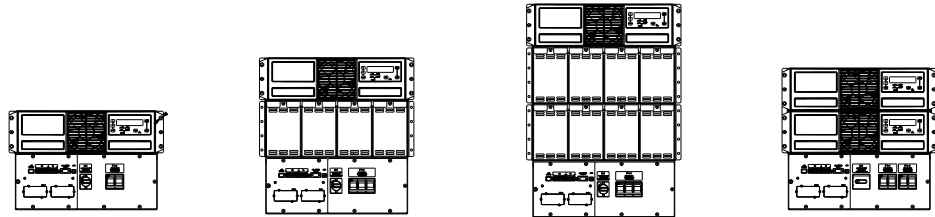

Subrack type	RI10	RI11	RI12	RI20
Number of modules	1	1	1	1 to 2
Dimension w × h × d	448 × 310 × 565 mm	448 × 487 × 735 mm	448 × 665 × 735 mm	448 × 440 × 565 mm
Internal battery capacity	–	Up to 40 blocks 7/9Ah	Up to 80 blocks 7/9Ah	–

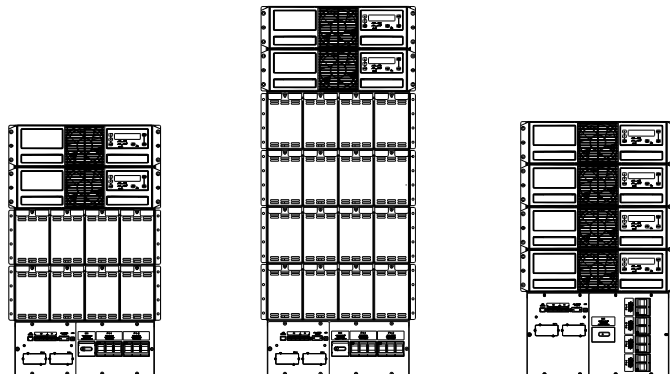

Subrack type	RI22	RI24	RI40
Number of modules	1 to 2	1 to 2	1 to 4
Dimension w × h × d	448 × 798 × 735 mm	448 × 1153 × 735 mm	448 × 798 × 735 mm
Internal battery capacity	Up to 80 blocks 7/9Ah	Up to 160 blocks 7/9Ah	–

### UPS subrack configuration

- Up to four online double conversion modules
- Individual module display
- Input, bypass and battery protection fuses
- Manual bypass switch
- Single- and dual-input feed available
- Free space to place internal battery modules (only for UPScale RI 11/12/22/24)
- Communication interfaces: RS-232 port, five input/output dry contacts (incl. EPO and GEN On)

### Options

- Integrated back-feed protection
- Cold start
- Halogen-free cabling
- Conformal coating
- Internal battery modules
- Battery temperature sensor
- Remote panel (graphical touch screen display)
- Control and monitoring (ModBus RS-485, ModBus TCP/IP, SNMP)

# DPA UPScale RI

## Technical specification

General data	RI10	RI11	RI12	RI20	RI22	RI24	RI40
Nominal power per module	10kW/20kW						
Nominal power / frame	20kW	20kW	20kW	40kW	40kW	40kW	80kW
UPS modules	1	1	1	1 to 2	1 to 2	1 to 2	1 to 4
Maximum number of inbuilt batteries (7/9Ah)	-	40	80	-	80	160	-
Output power factor	1.0						
Topology	Online double conversion						
UPS type	Modular (Decentralized Parallel Architecture)						
<b>Input</b>							
Nominal input voltage	3×380/220V+N, 3×400/230V+N, 3×415/240V+N						
Voltage tolerance (referred to 3×400/230V)	For loads <100% (-20%, +15%), <80% (-26%, +15%), <60% (-35%, +15%)						
Input distortion THDi	≤3%						
Frequency	35–70 Hz						
Power factor	0.99						
<b>Output</b>							
Rated output voltage	3×380/220V+N, 3×400/230V+N, 3×415/240V+N						
Voltage distortion	<1.5%						
Frequency	50Hz or 60Hz						
Overload capability	1 min.: 150% / 10 min.: 125%						
Unbalanced load	100% (all three phases regulated independently)						
Crest factor	3:1 (load supported)						
<b>Efficiency</b>							
Overall efficiency	Up to 96%						
In eco-mode configuration	98%						
<b>Environment</b>							
Storage temperature	-25 °C to +70 °C						
Operating temperature	0 °C to +40 °C						
Altitude configuration	1000m without derating						
<b>Communications</b>							
LCD	Yes (per module)						
LEDs	LED for notification and alarm						
Communication ports	USB, RS-232, SNMP slot, potential-free contacts						
<b>Standards</b>							
Safety	IEC/EN 62040-1						
Electromagnetic compatibility (EMC)	IEC/EN 62040-2						
Performance	IEC/EN 62040-3						
Product certification	CE						
Manufacturing	ISO 9001:2015, ISO 14001:2015, OHSAS18001						
<b>Weight, dimensions</b>							
Weight (with modules / without batteries)	Up to 39kg	Up to 62kg	Up to 78kg	Up to 68kg	Up to 109kg	Up to 136kg	Up to 136kg
Dimensions w × h × d (mm)	488 × 310 × 565 (7HU)	488 × 487 × 735 (11HU)	488 × 665 × 735 (15HU)	488 × 440 × 565 (10HU)	488 × 798 × 735 (18HU)	488 × 1153 × 735 (26HU)	488 × 798 × 735 (18HU)



50 S4

**DPA**  
INSIDE

**Caution!**  
- Risk of electric shock -  
capacitor stores hazardous  
energy. Do not remove cover until  
5 minutes after disconnecting all  
sources of supply

**Attention! Avertissement!**  
- Risque de choc électrique -  
énergie stockée dans les  
condensateurs. Attendre au  
moins 5 minutes après avoir  
débranché toutes les sources

**DPA**  
INSIDE

**Attention! Avertissement!**  
- Risque de choc électrique -  
énergie stockée dans les  
condensateurs. Attendre au  
moins 5 minutes après avoir  
débranché toutes les sources

**Made in Switzerland**  
**CE**  
Output Power: 50 kW  
Output Voltage: 72.5 V  
Output Current: 50 A  
Output Freq.: 50 Hz  
Production Date: 1 9 1 8

DELTA  
VENICUT APBLUS  
ENIGMA  
32GR 8  
AMS  
OUT  
2  
023

Only a truly redundant architecture like DPA allows online modules to be swapped out while the system is running.

# DPA 250 S4

## The world's most energy-lean UPS

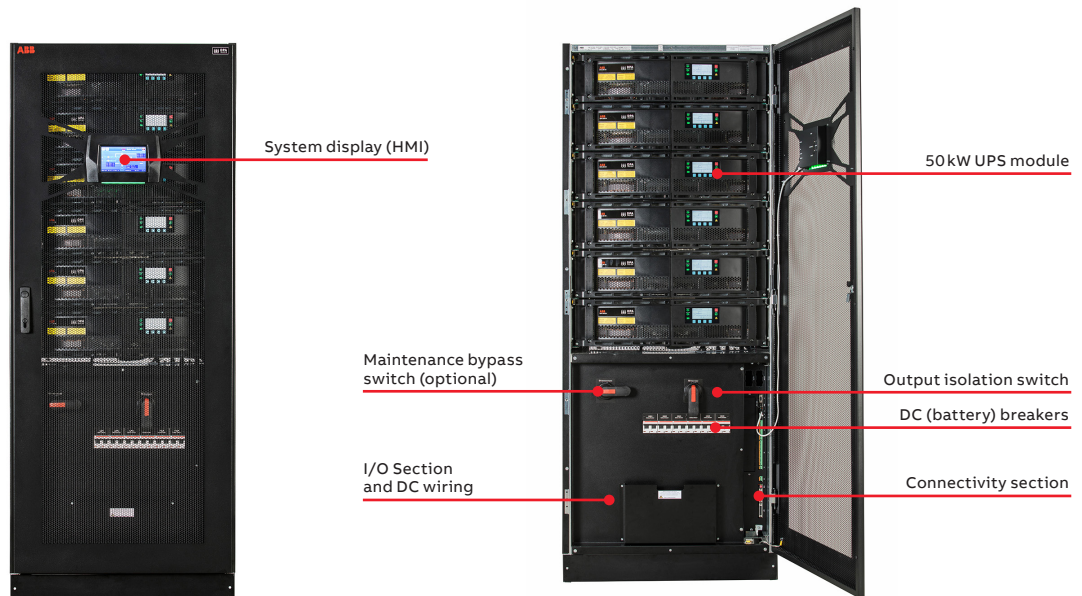

The DPA 250 S4 has a high-efficiency, modular architecture that offers best reliability for environmentally conscious organizations that also need zero downtime and low cost of ownership. The DPA 250 S4 is specially designed for critical, high-density computing environments such as small- to medium-sized data centers.

The DPA 250 S4 sets the standard for the next decade of UPS progress with advanced features such as its transformer-free IGBT converters that feature three-level topology with interleaving controls to enable market-leading efficiency of 97.6 percent for the UPS module. This high efficiency reduces operational costs and minimizes environmental impact.

### High efficiency reduces total cost of ownership

- DPA 250 S4 can reduce energy losses by more than 30 percent compared to similar products in the market
- Thanks to three-level interleaved technology, the DPA 250 S4 achieves an energy efficiency of over 97 percent in a wide operating range
- Xtra VFI – double conversion mode maximizes efficiency under low-load conditions

### Full flexibility to meet a variety of installation schemes

- Small installation footprint saves space
- DPA 250 S4 is adaptable to different installation schemes
- Variety of options for energy backup, including lithium-ion batteries
- The DPA 250 S4's battery charger is very powerful, ready to support the critical load in the next outage

### Uninterruptible power – scalable from 50 kW up to 1.5 MW

- 50 kW power in one UPS module
- 300 kW power in one UPS cabinet
- Up to five frames and up to 30 modules can be paralleled for an amazing 1,500 kW of uninterruptible power.
- Secure ring communication ensures there is no single point of failure in the system

### Easy to operate – fast and secure to maintain

- A well-thought-out electrical and mechanical scheme reduces scope for human error and makes the fast and secure to maintain and service
- It takes only 10 minutes to extract a module, insert it back to the system and turn it back online
- DPA 250 S4 has a very robust design and features practical handles (e.g. mechanical stoppers to stop the modules from sliding out too far)
- Easy of monitoring at system and module level



# DPA 250 S4

## Product features

### Energy saving in action

Featuring superior 97.6 percent UPS module efficiency and 97.4 percent system efficiency, the DPA 250 S4 reduces energy losses that create pure costs as direct electricity spend and costs for cooling. Thanks to three-level interleaved technology, the DPA 250 S4 achieves an efficiency of over 97 percent in a wide operating range, when the load is between 25 and 75 percent of nominal capacity.

### DPA 250 S4 50 kW UPS module

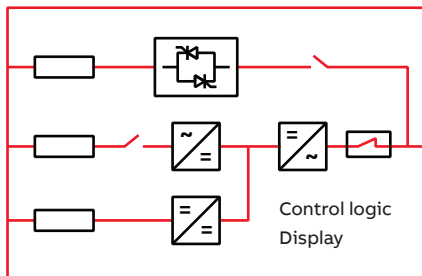

### Fail-safe operation for high power applications

When multiple DPA 250 S4 cabinets are connected in parallel for capacities beyond 300 kW, secure ring communication ensures system reliability is maintained, and that there is no single point of failure.

The ring communication technique loops back the parallel communication cable from the last frame in the system. This introduces an alternative communication path in case one cable in between two frames is disconnected for some reason.

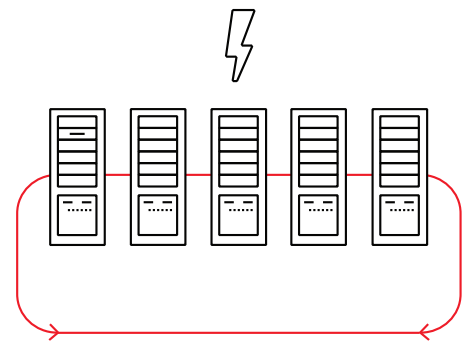

### Xtra VFI – double conversion mode maximizes efficiency under low-load conditions

Under operating conditions where the load is low compared to UPS total capacity, the DPA 250 S4 can step up the system efficiency by optimizing the number of modules used in double conversion mode to feed the load. In case of a load step, more modules are switched automatically in milliseconds to online mode to secure the critical load.

### Uninterruptible power – scalable from 50 kW up to 1.5 MW

A benefit of a modular UPS is that capacity can be easily scaled up or down. UPS system power can be optimized to match the load and upgraded easily if power demand increases. Featuring smart and secure power connectors, the DPA 250 modules can be removed, or added, while other UPS modules in the system support the load in double conversion mode.

# DPA 250 S4

## Available models

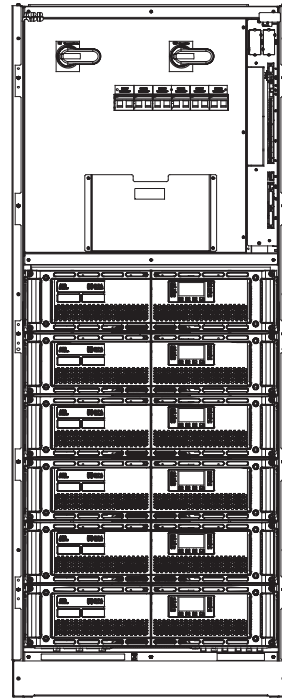
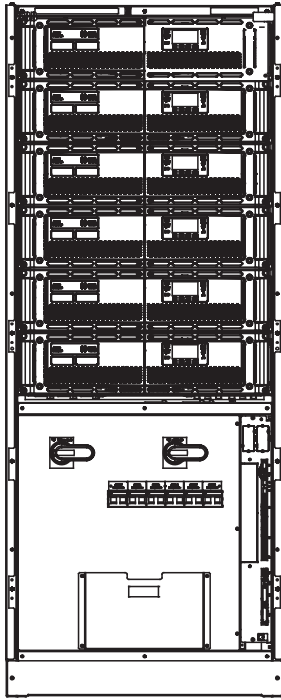

<b>Cabinet type</b>	<b>300 kW</b>
<b>Dimensions w x h x d</b>	795 x 1978 x 943 mm
<b>Capacity</b>	Up to six modules
<b>Weight module in kg</b>	66
<b>Weight in kg (without batt. /mod.)</b>	270

### UPS cabinet configuration

- UPS frame equipped with up to 6 x UPS module slots
- Top or bottom cable entry (standard)
- Single- and dual-input feed available
- Inbuilt output isolator
- Inbuilt back-feed protection
- Bypass fuses and battery circuit breaker for each module
- UPS module with HMI interface
- Communication interfaces: RS-232 and USB ports, I/O dry contacts (EPO, GEN On, ...) and interface for external key interlock (bypass)

### Options

- Manual bypass switch (one-frame applications)
- Graphical touch screen system display
- Elevation kit
- Control and monitoring (ModBus RS-485, ModBus TCP/IP, SNMP and others)
- Battery temperature sensor
- Halogen free cable
- Cold start

# DPA 250 S4

## Technical specification

<b>GENERAL DATA</b>	
System power range	50 - 1,500 kW
Nominal power / module	50 kW
Nominal power / frame	300 kW
Output power factor	1.0
Topology	Online double conversion, Decentralized Parallel Architecture
Number of UPS modules	6
Parallel configuration	Up to 30 modules
Cable entry	Top or bottom
Serviceability	Only frontal access needed
Back-feed protection	Built-in as standard
<b>INPUT</b>	
Nominal input voltage	380 / 400 / 415 VAC
Voltage tolerance (referred to 400 V)	- 30% at partial loads
Current distortion THDi	<3%
Frequency range	35 – 70 Hz
Power factor	0.99
Walk in / soft start	Yes
<b>OUTPUT</b>	
Rated output voltage	380 / 400 / 415 VAC
Voltage tolerance (referred to 400 V)	± 1.0%
Voltage distortion THDU	<2.0%
Frequency	50 or 60 Hz (selectable)
<b>EFFICIENCY</b>	
Module efficiency	Up to 97.6%
Overall system efficiency	Up to 97.4%
In eco-mode	Up to 99%
<b>ENVIRONMENT</b>	
Protection rating	IP 20 (IP 21 optional)
Storage temperature	-25°C to +70°C
Operating temperature	0°C to +40°C
Altitude (above sea level)	1,000 m w/o derating
<b>BATTERIES</b>	
Types	VRLA, open cells, NiCd and Li-Ion
<b>COMMUNICATIONS</b>	
User interface	System graphical display UPS Module HMI interface
Communication ports	USB, RS-232, potential-free contacts, SNMP (optional)
Customer interface	Remote shutdown, gen-set interface, external bypass contact
<b>COMPLIANCY</b>	
Safety	IEC / EN 62040-1
EMC	IEC / EN 62040-2
Performance	IEC / EN 62040-3
Manufacturing	ISO 9001:2015, ISO 14001:2015, OHSAS18001
<b>DIMENSIONS</b>	
Weight (without modules / without batteries)	270 kg
Weight module	66 kg
Dimensions w x h x d	795 x 1978 x 943 mm

# DPA 500

The modular UPS for medium-sized and large data centers

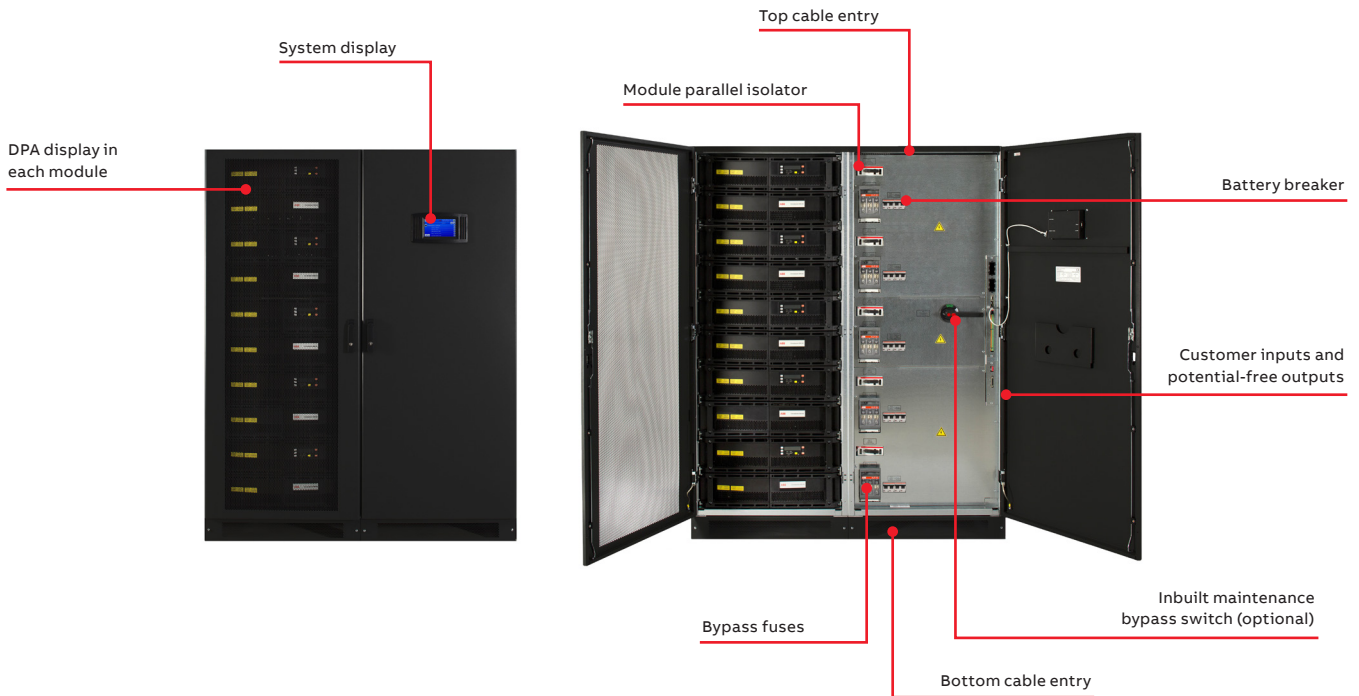

A data center with full uptime. That target is why ABB's DPA 500 is based on Decentralized Parallel Architecture (DPA). Only a truly redundant architecture like DPA allows online modules to be swapped out while the system is running. Each high-reliability, standardized module is self-contained and can be swapped at any time, so

nothing has to be ever switched off – making routine maintenance safe and easy. And if you want to increase power, the UPS can be scaled vertically in 100kW modular steps to provide up to 500kW power in a single frame. Horizontal scalability is also given, with up to six frames in parallel, to increase total power up to 3MW.

#### 99.9999% (6 nines) availability

- Decentralized Parallel Architecture
- Replace or add modules with no downtime
- Short mean time to repair
- No single points of failure

#### Cost effective "right-sizing"

- Scalable up to 3MW
- Vertical and horizontal scalability

#### Low total cost of ownership

- Up to 96% true online efficiency
- Eco-mode efficiency  $\geq 99\%$
- Small footprint / high power density
- Unity power factor (kW = kVA)
- Low input harmonic distortion (THDi  $< 3.5\%$ )

#### Efficient service concept

- Simple power upgrade
- Fast maintenance
- Reduced spare parts needed
- Full front access

# DPA 500

## Product features

01 The power demand of one row of server racks can vary from 100kW up to hundreds of kW. The building block concept of DPA 500 allows adaption to the changes in power demand in a growing infrastructure.

**Total vertical and horizontal scalability**  
The DPA 500 delivers power protection from 100 to 500kW (one to five modules) in a single cabinet (vertical scalability). Cabinets can operate in a parallel configuration to build a system of up to 3MW (horizontal scalability).



$$6 \times 5 \times 100_{\text{kW}} = 3 \text{ MW}$$

02 The sample reference scenario, 1200 kW Tier 4, illustrates one possible example of how the DPA 500 can be used to create a high-performance and flexible IT infrastructure. Extra modules can be added while the system is powered up to make it up to 3MW.

**Designed with maximum flexibility at its core**  
The system flexibility allows upgrading or downgrading power capacity according to your needs.

### End of rack raw applications

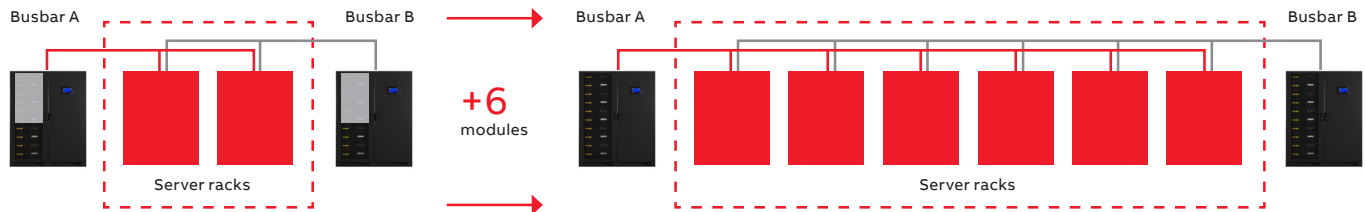

01

### Dual-bus power protection solutions

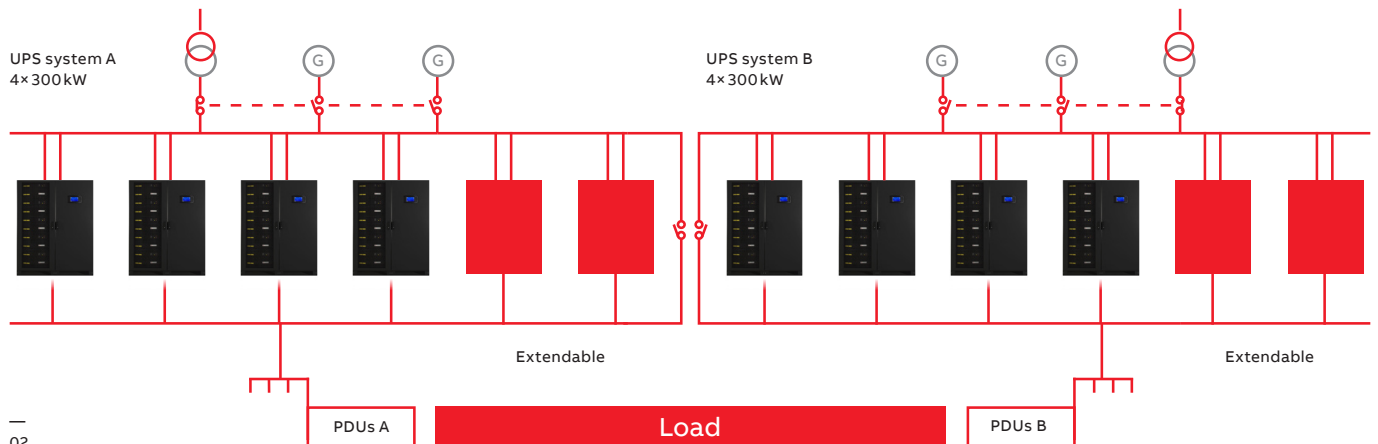

02

# DPA 500

## Available model

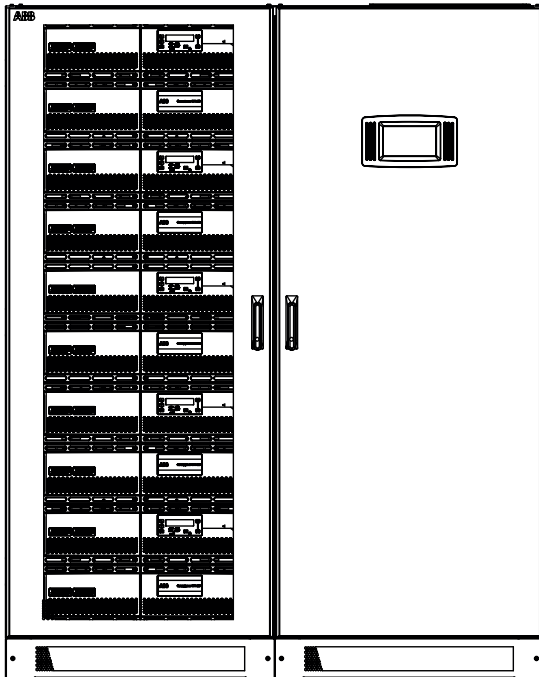

<b>Cabinet type</b>	<b>DPA – 500 kW</b>
<b>Dimensions w × h × d</b>	1580 × 1975 × 945 mm
<b>Capacity</b>	Up to five modules
<b>Weight in kg</b>	975 kg (500 kW system)

### UPS cabinet configuration

- Online double conversion UPS
- Inbuilt module isolator
- Inbuilt back-feed protection
- Individual module display
- HMI interface with mimic diagram and LCD
- Top or bottom cable entry (standard)
- Single- and dual-input feed available
- Bypass fuses and battery circuit breaker for each module
- Graphical touch screen system display
- Communication interfaces: RS-232 and USB ports, I/O dry contacts (EPO, GEN On, ...) and interface for external key interlock (bypass)

### Options

- Manual bypass switch (one-frame applications)
- Control and monitoring (ModBus RS-485, ModBus TCP/IP, SNMP and others)
- Remote panel (graphical touch screen display)
- Battery temperature sensor
- Cold start
- Synchronization kit

# DPA 500

## Technical specification

General data	
System power range	100kW–3MW
Nominal power / module	100kW
Nominal power / frame	500kW
Output power factor	1.0
Topology	Online double conversion, Decentralized Parallel Architecture
Parallel configuration	Up to 5 modules in one cabinet (500kW) / up to 6 cabinets in parallel (3MW)
Cable entry	Bottom or top as standard
Serviceability	Full front
Back-feed protection	Built-in as standard
Input	
Nominal input voltage	3× 380 / 220V + N, 3× 400 / 230V + N, 3× 415 / 240V + N
Voltage tolerance (referred to 400 / 230V)	For loads <100% (-10%, +15%), <80% (-20%, +15%), <60% (-30%, +15%)
Input distortion THDi	<3.5%
Frequency range	35–70Hz
Power factor	0.99
Walk in / soft start	Yes
Output	
Rated output voltage	3× 380 / 220V + N, 3× 400 / 230V + N, 3× 415 / 240V + N
Voltage tolerance (referred to 400 / 230V)	<±1% with static load / <±4% with step load
Voltage distortion	<2% with linear load / <4% with non linear load
Frequency	50 Hz or 60Hz (selectable)
Efficiency	
Overall efficiency	Up to 96%
In eco-mode	≥99%
Environment	
Protection rating	IP20
Storage temperature	-25°C to +70°C
Operating temperature	0°C to +40°C
Altitude (above sea level)	1000m without derating
Batteries	
Types	VRLA / NiCd / Li-Ion
Battery charger	Decentralized charger per module
Communications	
User interface	Graphical touch screen (one per frame as standard) Decentralized LCD and mimic diagram (one per module as standard)
Communication ports	USB, RS-232, potential-free contacts, SNMP (optional)
Customer interface	Remote shutdown, gen-set interface, external bypass contact
Compliance	
Safety	IEC / EN 62040-1
EMC	IEC / EN 62040-2
Performance	IEC / EN 62040-3
Manufacturing	ISO 9001:2015, ISO 14001:2015, OHSAS18001
Weight, dimensions	
Weight	975 kg (500kW system)
Dimensions w × h × d	1580 × 1975 × 940 mm

# MegaFlex DPA

## The best in power protection



The on-line double conversion MegaFlex DPA UPS provides the best power protection for your critical infrastructure from 250 kW to 1,500 kW. This modular UPS is specifically designed for critical high-density computing environments across private and public enterprise, as well as data centers for colocation, hosting cloud and telecommunications. The modular UPS is based on ABB's decentralized parallel architecture (DPA™).

This innovative system means every UPS module is practically its own UPS with all the essential functional units needed for independent operation. DPA provides full redundancy and fault tolerance in a way that is unique amongst UPS vendors. This results in increased system reliability and availability that outperforms every other modular UPS solution on the market.

---

### Flexible approach

- Easily scalable solutions
- Up to 1,500 kW power protection in a single UPS with add-on modules
- Redundant power capabilities: 1,000 kW N+1, 1,250 kW N+1
- Collaborative, customer-centered approach

### Reliable operations

- DPA™ technology maximizing power availability
- Online-swappable power modules for continuous uptime
- Automatic isolation of any faulty power module
- Fault-tolerant UPS design for uninterrupted power
- Ease of operation with local and remote real-time monitoring

### Optimized efficiency

- Minimized energy losses, heat dissipation and electricity cost in double conversion or eco mode
- Smart load-sharing optimizes energy consumption
- Optimized system efficiency under low load conditions with ABB Xtra VFI modes
- All guaranteed across the 15-year product lifespan

### Simple installation and serviceability

- Plug-in power modules support easy, safe connections
- Pre-engineered power frames eliminate wiring entirely
- Cleans and optimizes incoming power
- Automatic self-configuration and testing minimizes human intervention



# MegaFlex DPA

## Product features

### Flexible approach

As your power requirements increase, you need a UPS that grows with your infrastructure. With 3-4 power frame slots and connection frames of 1 MW or 1.5 MW, the MegaFlex DPA UPS offers a flexible mechanical layout that can adapt to your current system and future power expansion.

- Easily scalable modular system
- Power capacity can be optimized to match variable loads
- Easy upgrade for power demand increases
- Ease-of-use for operations personnel
- Simple maintenance
- Can be paralleled with up to four systems

### Optimized efficiency

Running a facility with high energy demands means that every percentage point of energy saved represents significant cost savings and a reduction in CO<sub>2</sub> emissions. The MegaFlex DPA UPS solution combines the highest efficiency ratings available with the smallest footprint.

- VFI double conversion operating mode with efficiency of up to 97.4 percent, rising to 99.4 percent efficiency in VFD ECO mode
- Up to 45 percent footprint savings with ultra-high kW per m<sup>2</sup>
- Optimized efficiency in partial-load conditions

### The most reliable UPS on the market

Critical, high-density computing environments demand a combination of guaranteed uptime and the highest safety standards to ensure both assets and people are protected.

- Automatic power module self-configuration and firmware updates
- Slide-in power modules for simple and safe installation
- Full lifetime service from ABB-trained specialists
- Enhanced power measurement, providing comprehensive data to track energy consumption

### Maintenance made easy

Serviceability has never been easier than with the MegaFlex DPA UPS's modular design. Each component has been expertly engineered to optimize accessibility and to reduce the possibility of human error.

Designed for ease of use from the first moment of installation, the module cabinets are easily transported to the UPS and slide into place on integrated wheels.

Docking connectors eliminate the threat of cabling faults during installation while entry points at the front and rear of the IP20-protected cabinet make connecting mains cabling convenient, safe and worry-free.

The fan array is mounted on a pull-out drawer for ease of access with failure detection and speed regulation provided as standard.



# MegaFlex DPA

## Available models

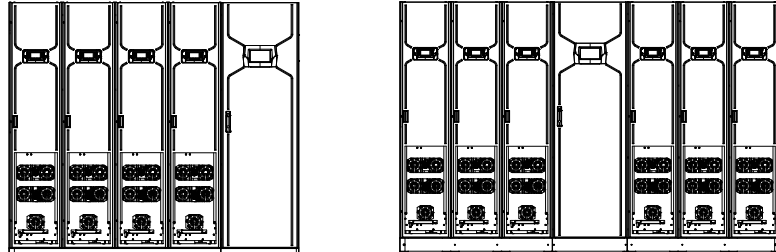

Cabinet type	1,000 kW	1,500 kW
Capacity	Up to four modules	Up to six modules
Weight [kg]	1940	3250
Dimensions w × h × d (mm)	2235 x 2000 x 1000	3045 x 2000 x 1000

### UPS cabinet configuration

- Available in two different frames (up to 1,000 kW / 1,500 kW)
- UPS frame equipped with up to 4 or 6 x UPS module slots
- Power modules of 250 kW
- Parallel system capability up to 4 UPS systems
- Single-input feed
- Top or bottom cable entry (standard)
- Frontal access for power frame and connection frame
- Inbuilt back-feed protection
- Separate battery kit
- Customer interface: UPS module with HMI interface, system graphical touch screen
- Communication ports: USB, RS-232, potential-free contacts, ABB network card

### Options

- Battery temperature sensor
- Common battery kit
- Synchronization kit
- Cold start
- Xtra VFI modes

# MegaFlex DPA

## Technical specification

<b>General data</b>			
System power rating [kW]	1,000	1,250	1,500
Core power rating [kW]	250		
Static bypass architecture	Distributed		
Parallel system capability	Up to 4 UPS system		
Topology	Online double conversion		
Cable entry	Top or bottom		
Serviceability	Frontal access for power frame and connection frame, removable power module with 360° access		
Back-feed protection	Built-in as standard		
<b>Input</b>			
Nominal input voltage	380 / 400 / 415 VAC		
Voltage tolerance (referred to 3x 400 / 230 V)	- 30% at partial loads		
Current distortion THDi	<4%		
Frequency range	35 – 70 Hz		
Power factor	0.99		
<b>Output</b>			
Rated output voltage	380 / 400 / 415 VAC		
Voltage tolerance (referred to 400 V)	± 1%		
Voltage distortion THDU	<2.0%		
Frequency	50 or 60 Hz (selectable)		
Rated power factor	1.0		
<b>Efficiency</b>			
Max system efficiency (VFI) @ 50% load	97.4%		
Overall system efficiency (VFI)	Over 97% with varying of load		
In eco-mode (VFD)	Up to 99%		
<b>Environment</b>			
Protection rating	IP 20		
Storage temperature	-25 °C to +70 °C		
Operating temperature	0 °C to +40 °C		
Altitude (above sea level)	1,000 m w/o derating		
<b>Communications</b>			
User interface	System graphical touch screen		
Communication ports	USB, RS-232, potential-free contacts, ABB network card		
Customer interface	Remote shutdown, gen-set interface, external bypass contact		
<b>Batteries</b>			
Types	VRLA, open cells, NiCd and Li-Ion		
Charger	Decentralized battery charger per power module		
<b>Standards</b>			
Safety	IEC / EN 62040-1		
EMC	IEC / EN 62040-2		
Performance	IEC / EN 62040-3		
Manufacturing	ISO 9001:2015, ISO 14001:2015, OHSAS18001		
<b>Weight, dimensions</b>			
Weight [kg]	1940	2900	3250
Dimensions w × h × d (mm)	2235 x 2000 x 1000	3045 x 2000 x 1000	3045 x 2000 x 1000

# PowerLine DPA

## Full power for industrial applications

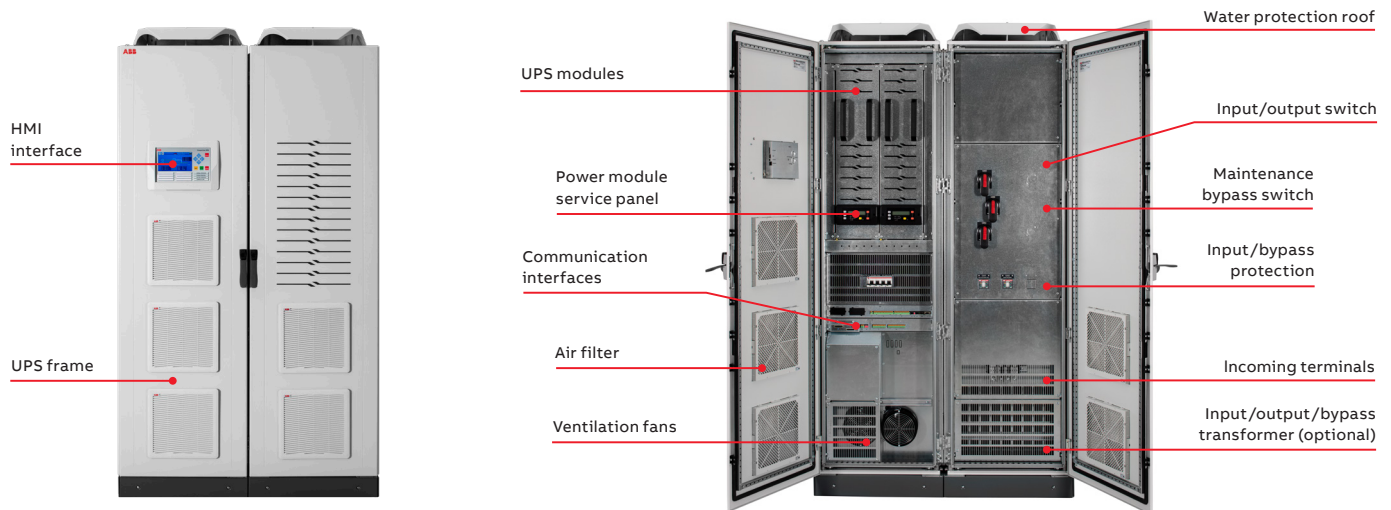

PowerLine DPA (3ph and 1ph) is an online double conversion UPS and makes the advantages of ABB's unique modular UPS architecture available for locations that are usually rough on electronic equipment. PowerLine DPA is based on ABB's Decentralized Parallel Architecture (DPA) that ensures the very best UPS design in terms of availability, serviceability, safety and ease of use.

Its robust design is suitable for industrial plant environments that have a variety of temperatures, dust, moisture and corrosive contaminants. The PowerLine DPA is designed to have a design life of 15 years. Its pre-configured options, tailored for industry, allow agile implementations with short lead times.

### Fail safe electrical design

- High overload and short circuit capability
- System integrated galvanic isolation and step up-down voltage transformers (optional)
- High capacity for battery current charge for long battery banks

### High availability

- Decentralized Parallel Architecture (DPA)
- Replace or add modules with no downtime (online swappable)

### Fail safe mechanical design

- High degree of protection: IP31 (standard), IP42 (optional)
- Designed for deployment in demanding industrial situations
- Small foot print/high power density

### Efficient service concept

- User-friendly operating interface
- Fast maintenance
- Full front access
- Reduced spare parts needed

# PowerLine DPA

## Product Features

—  
01 Local control and metering are provided via a HMI (human-machine interface) consisting of graphical display showing the UPS mimic diagram, UPS operating status (normal, battery and bypass), and programmable alarms.

### The robust UPS

PowerLine DPA's IP31-rated protection can easily cope with dust, water condensation, excessive humidity (up to 95 percent), corrosive air contamination and rough manhandling. The UPS is designed to operate in a temperature range of  $-5$  to  $+45^{\circ}\text{C}$ . High priority has been given to safety and PowerLine DPA features a high degree of protection for users and maintenance staff. The device's compliance with the relevant standards – IEC/EN 62040-1 for general and safety aspects, IEC/EN 62040-2 for EMC and IEC/EN 62040-3 for performance and test – has been verified. All sort of transformers are available to meet customer voltage requirements and electrical isolation. In addition, PowerLine DPA has a high overload capacity and robust short-circuit capability, and is available with rated powers of 20 to 120 kVA. With input and output (three-phase) voltages in the range 220 to 415 VAC the UPS requires no onerous electrical installation considerations and is straightforward to service.

### Monitoring

PowerLine DPA UPS can be supplied with relay boards and a network management card that provide connection to a DCS (distributed control system) or SCADA (supervisory control and data acquisition) system via SNMP, ModBus TCP or ModBus RS-485.

These interfaces allow:

- Environmental monitoring
- Extensive alarm handling and dispatching
- Redundant UPS monitoring
- Integration of PowerLine DPA into multivendor and multiplatform environments
- The supply of UPS data to Web applications

### Battery bank

Most industrial processes will draw substantial amounts of power from a UPS. Therefore, PowerLine DPA is able to work with valve-regulated lead-acid (VRLA), NiCad and lithium-ion batteries to support autonomy times up to 10h. Fast recharging is also catered for to get the UPS battery bank back up to operational levels as quickly as possible.

—  
01



# PowerLine DPA

## Available models

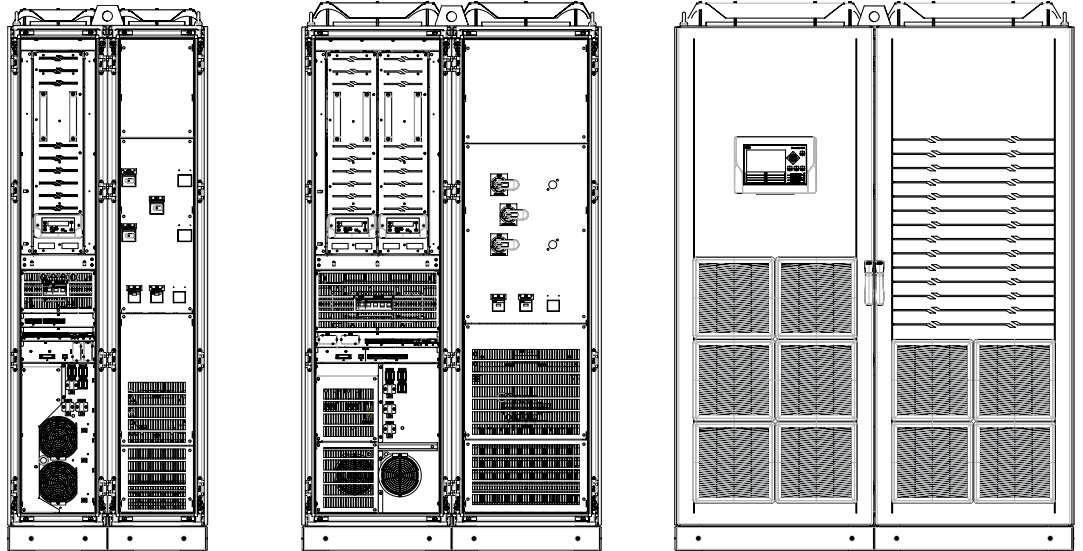

Cabinet type	PowerLine DPA 40	PowerLine DPA 80	PowerLine DPA 120
Number of modules	1	2	3
Dimension w × h × d	800×2200×800 mm	1200×2200×800 mm	1600×2200×800 mm
Weight in kg (without transformers)	Up to 300 kg	Up to 500 kg	Up to 850 kg

### UPS cabinet configuration

- 3ph and 1ph online double conversion UPS
- Decentralized Parallel Architecture
- Housed in an industrial metal enclosure, IP31, RAL 7035, bottom cable entry
- Halogen free cable
- Forced ventilation with monitored fans
- Input, bypass and battery protection
- Manual bypass switch
- Integrated back-feed protection
- HMI interface with graphical display, control push keys, UPS operating status indication and programmable alarm section
- Communication interfaces: Relay board with 9 programmable outputs and 8 inputs, RS-232 and USB ports

### Options

- Input, output, bypass aluminum transformer
- Customized input & output voltages
- Ingress protection IP42
- Top cable entry
- Redundant fan monitoring (N + 1)
- Tropicalization and anti-corrosion protection for electrical boards
- Anti-condensator heater
- Lifting eyes
- Control and monitoring (ModBus RS-485, ModBus TCP/IP, SNMP)
- Battery temperature sensor
- Cold start
- Redundant configuration

# PowerLine DPA

## Technical specification

General data	PowerLine DPA 40	PowerLine DPA 80	PowerLine DPA 120
<b>System power range</b>	20 - 120 kVA (3ph); 20 - 80 kVA (1ph)		
<b>Nominal power / frame</b>	20kVA	40kVA	80kVA
<b>Number of UPS modules</b>	1	2	3
<b>Output power factor</b>	1.0		
<b>Topology</b>	Online double conversion		
<b>UPS configuration</b>	Single, redundant, dual, N+1		
<b>UPS type</b>	Modular (Decentralized Parallel Architecture)		
<b>Input</b>			
<b>Nominal input voltage</b>	3×400/230V+N		
<b>Voltage tolerance (referred to 3×400/230V)</b>	For loads <100% (-15%, +10%), <80% (-20%, +10%), <60% (-25%, +10%)		
<b>Input distortion THDi</b>	≤4%		
<b>Frequency</b>	50 or 60 (selectable)		
<b>Power factor</b>	0.99		
<b>Output</b>			
<b>Rated output voltage</b>	3× 400/230 AV (3ph); 230 (1ph)		
<b>Voltage distortion (referred to 3×400/230V)</b>	<1%		
<b>Frequency</b>	50 Hz or 60 Hz		
<b>Overload capability</b>	150% 1 min, 125% 10 min		
<b>Output short capability</b>	2.7× Inom (3ph); 2.4 × Inom (1ph)		
<b>Unbalanced load</b>	100% (all three phases regulated independently)		
<b>Crest factor</b>	3:1 (load supported)		
<b>Efficiency</b>			
<b>Overall efficiency / transformerless</b>	Up to 96% (3ph); 94% (1ph)		
<b>In eco-mode configuration</b>	98%		
<b>Environment</b>			
<b>Storage temperature</b>	-25 °C to +70 °C		
<b>Operating temperature</b>	-5 °C to +45 °C		
<b>Humidity</b>	5% to 95% without condensation		
<b>Altitude</b>	1000 m without derating		
<b>Electrical / Mechanical</b>			
<b>Degree of protection</b>	IP31, IP42 (optional)		
<b>Color</b>	RAL 7035		
<b>Cable entry</b>	Bottom, Top (optional)		
<b>Wiring</b>	Halogen free cable		
<b>Operating and maintenance access</b>	Front access		
<b>Ventilation</b>	Forced ventilation with monitored fans		
<b>Battery</b>			
<b>Battery type</b>	VRLA / NiCd / Li-Ion		
<b>Autonomy</b>	According to customer's requirement		
<b>Communications</b>			
<b>HMI</b>	Graphical display for control and metering, 8 programmable alarm indications		
<b>Relay contactors</b>	8 in /9 out programmable relays		
<b>LCD</b>	On system level HMI with graphical display and alarm indications; on module level service control interface		
<b>LEDs</b>	LED for notification and alarm		
<b>Communication ports</b>	USB, RS-232, SNMP slot, potential-free contacts		
<b>Standards</b>			
<b>Safety</b>	IEC / EN 62040-1		
<b>Electromagnetic compatibility (EMC)</b>	IEC / EN 62040-2		
<b>Performance</b>	IEC / EN 62040-3		
<b>Product certification</b>	CE		
<b>Manufacturing</b>	ISO 9001:2015, ISO 14001:2015, OHSAS18001		
<b>Weight, dimensions</b>			
<b>Weight (with modules /without transformers)</b>	Up to 300 kg	Up to 500 kg	Up to 850 kg
<b>Dimensions w × h × d (mm)</b>	800×2200×800 mm	1200×2200×800 mm	1600×2200×800 mm

# PowerValue 11LI UP

A line-interactive UPS to suit all pockets



Intended for users with lower power requirements, the line-interactive PowerValue 11LI Up delivers from 600 up to 2,000 VA electrical power, making it the ideal UPS for modest IT applications. As well as intervening within 2 to 6 ms to power your application when mains power is lost, the PowerValue 11LI Up also filters out input power disturbances such as surges, line noise or brownouts. If the input power factor starts to play up, the PowerValue 11LI Up will automatically correct it.

This UPS solution has been created to make life easy for the user:

- An intuitive touchscreen display allows parameters to be read with the minimum of fuss.
- USB and RS232 interfaces give access to the outside world.
- Dedicated RJ11/RJ45 sockets protect connected telecoms devices.

The UPS's internal enhanced-runtime batteries are designed to give you stable, low-maintenance performance over many years of service. When they eventually have to be replaced, this can be done without opening the cabinet. The slot to access the batteries is located at the bottom. A comprehensive battery management suite and fan cooling ensure batteries are not overloaded and that they do not overcharge, discharge too deeply or overheat.

## Enhanced runtime

- Up to four minutes autonomy with typical IT load
- High quality batteries ensure stable performance over years
- Minimize the costs related to battery maintenance and replacement

## Compact size

- Small footprint
- Easy to place nearby a laptop or monitor

## Easy battery replacement

- Change your battery in seconds
- Easy and safe access to the internal battery
- No need to dismantle the whole cabinet

## Touchscreen LCD display

- All information in a tap
- More user friendly than a LED interface



# PowerValue 11LI Up

## Available models

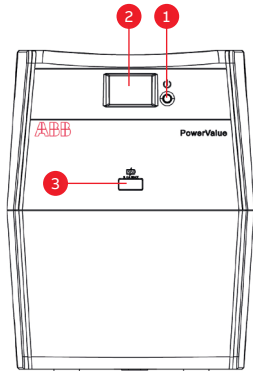

600-2000 VA  
Front view

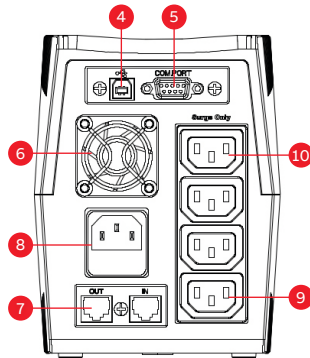

600-800 VA  
Rear view

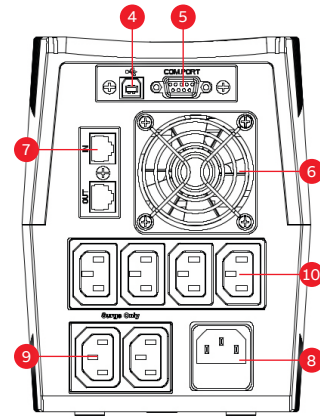

1000-1500-2000 VA  
Rear view

1. Standby/line mode button and power LED	4. USB	7. RJ11/RJ45 data protection	10. Backup sockets
2. Touchscreen LCD display	5. RS232	8. AC input	
3. USB charger (5 V, 2 A)	6. Fan	9. Surge only sockets	

### Technical specifications

	11LI Up 600VA	11LI Up 800VA	11LI Up 1000VA	11LI Up 1500VA	11LI Up 2000VA
<b>Rated power</b>	360 W	480 W	600 W	900 W	1200 W
<b>Nominal AC input/ output voltage</b>	230 VAC	230 VAC	230 VAC	230 VAC	230 VAC
<b>AC input voltage window</b>	170 – 280 VAC	170 – 280 VAC	170 – 280 VAC	170 – 280 VAC	170 – 280 VAC
<b>AC output voltage tolerance</b>	-17.1 % / +15.5% (line mode) ±10% (battery mode)	-17.1 % / +15.5% (line mode) ±10% (battery mode)	-17.1 % / +15.5% (line mode) ±10% (battery mode)	-17.1 % / +15.5% (line mode) ± 10% (battery mode)	-17.1 % / +15.5% (line mode) ± 10% (battery mode)
<b>Input Frequency</b>	50 / 60 Hz	50 / 60 Hz	50 / 60 Hz	50 / 60 Hz	50 / 60 Hz
<b>Output Frequency</b>	50 Hz (60 Hz) ± 1 Hz	50 Hz (60 Hz) ± 1 Hz	50 Hz (60 Hz) ± 1 Hz	50 Hz (60 Hz) ± 1 Hz	50 Hz (60 Hz) ± 1 Hz
<b>Efficiency</b>	≥95%	≥95%	≥95%	≥95%	≥95%
<b>Transfer time</b>	2-6 ms	2-6 ms	2-6 ms	2-6 ms	2-6 ms
<b>Battery type</b>	1x7.2 Ah	1x8 Ah	2x7.2 Ah	2x8 Ah	2x8 Ah
<b>Battery recharge time</b>	6-8 hrs	6-8 hrs	6-8 hrs	6-8 hrs	6-8 hrs
<b>Runtime in minutes at typical load (60%)</b>	1' 55"	1' 27"	3' 17"	4' 10"	2' 24"
<b>Ambient temperature</b>	0-40°C	0-40°C	0-40°C	0-40°C	0-40°C
<b>Max rel. humidity</b>	0-90% not condensing	0-90% not condensing	0-90% not condensing	0-90% not condensing	0-90% not condensing
<b>Storage temperature</b>	-20 to 50°C	-20 to 50°C	-20 to 50°C	-20 to 50°C	-20 to 50°C
<b>Net weight</b>	4.1 kg	4.7 kg	7.5 kg	9.8 kg	10.7 kg
<b>Dimensions (WxHxD)</b>	122x160x315 mm	122x160x315 mm	145x190x335 mm	145x190x335 mm	145x190x335 mm

# PowerValue 11LI Pro

A line-interactive UPS ideal for entry-level network equipment



Intended for entry-level network applications – such as server rooms in offices, network cabinets, workstation clusters, domestic networks, point-of-sale, network-attached data storage arrays and similar-sized situations – the line-interactive PowerValue 11LI Pro delivers from 600 up to 2,000 VA electrical power. This advanced protection ensures your connected equipment always sees a clean, regulated and reliable pure sinusoidal voltage.

This UPS solution has been created to make life easy for the user:

- An intuitive LCD display allows parameters to be read with the minimum of fuss.
- USB and RS232 interfaces give access to the outside world.
- Dedicated RJ11/RJ45 sockets protect connected telecoms devices.

The UPS's internal enhanced-runtime batteries are designed to give you stable, low-maintenance performance over many years of service. When they eventually have to be replaced, this can be done by opening only the front panel. A comprehensive battery management suite and fan cooling ensure batteries are not overloaded and that they do not overcharge, discharge too deeply or overheat.

ABB's design, technology and quality experience in high-end UPS engineering has been distilled into the line-interactive PowerValue 11LI Pro to produce a UPS that offers full protection and peace of mind for your moderately sized IT applications.

## Enhanced runtime

- Up to six minutes with typical IT load
- High quality batteries ensure stable performance over years
- Minimize the costs related to battery maintenance and replacement

## Compact size

- Small footprint
- Easy to place nearby a laptop or monitor, underneath a table or at the bottom of an IT rack

## Easy battery replacement

- Change your battery in seconds
- Easy and safe access to the internal battery
- No need to dismantle the whole cabinet

## Pure sinewave output

- Less harmonics content, lower fan speed and reduced acoustic noise
- Improved load performance and prolonged lifetime

# PowerValue 11LI Pro

## Available models

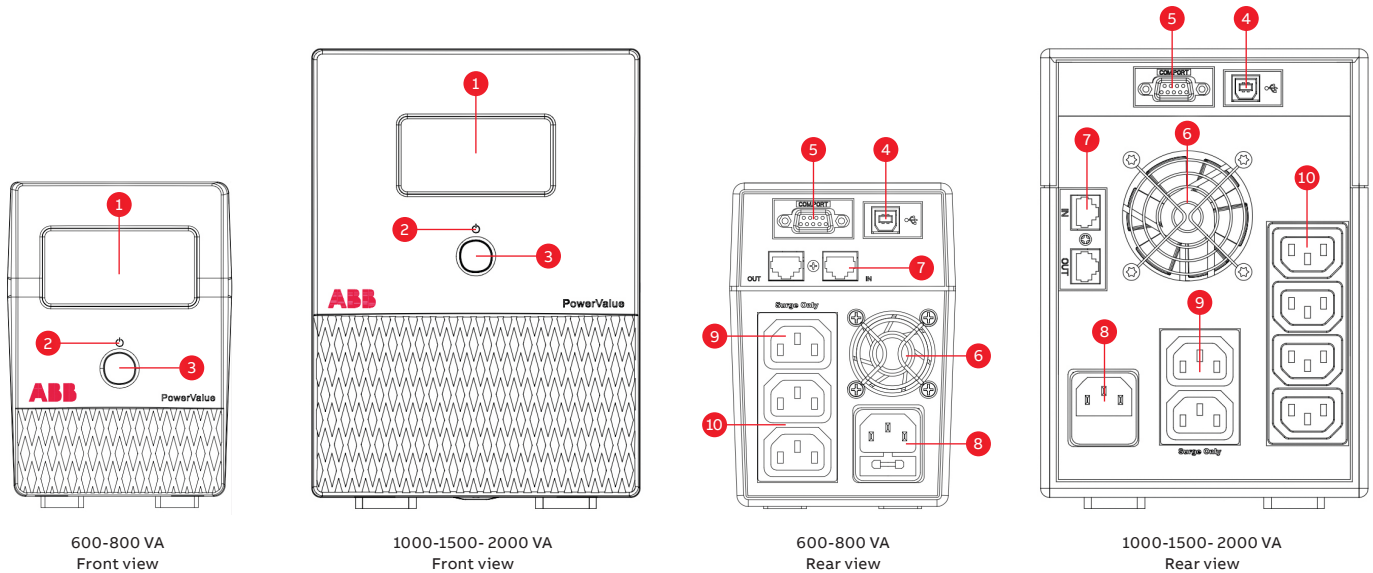

1. LCD display	4. USB	7. RJ11/RJ45 data protection	10. Backup sockets
2. Power LED	5. RS232	8. AC input	
3. On/off button	6. Fan	9. Surge only sockets	

### Technical specifications

	11LI Pro 600VA	11LI Pro 800VA	11LI Pro 1000VA	11LI Pro 1500VA	11LI Pro 2000VA
<b>Rated power</b>	360 W	480 W	700 W	1050 W	1400 W
<b>Nominal AC input/ output voltage</b>	230 VAC	230 VAC	230 VAC	230 VAC	230 VAC
<b>AC input voltage window</b>	170 – 280 VAC	170 – 280 VAC	170 – 280 VAC	170 – 280 VAC	170 – 280 VAC
<b>AC output voltage tolerance</b>	-17.1 % / +15.5% (line mode) ±10% (battery mode)	-17.1 % / +15.5% (line mode) ±10% (battery mode)	-17.1 % / +15.5% (line mode) ±10% (battery mode)	-17.1 % / +15.5% (line mode) ±10% (battery mode)	-17.1 % / +15.5% (line mode) ±10% (battery mode)
<b>Input Frequency</b>	50 / 60 Hz	50 / 60 Hz	50 / 60 Hz	50 / 60 Hz	50 / 60 Hz
<b>Output Frequency</b>	50 Hz (60 Hz) ± 1 Hz	50 Hz (60 Hz) ± 1 Hz	50 Hz (60 Hz) ± 1 Hz	50 Hz (60 Hz) ± 1 Hz	50 Hz (60 Hz) ± 1 Hz
<b>Efficiency</b>	≥95%	≥95%	≥95%	≥95%	≥95%
<b>Transfer time</b>	2-6 ms	2-6 ms	2-6 ms	2-6 ms	2-6 ms
<b>Battery type</b>	1x7.2 Ah	1x8 Ah	2x7.2 Ah	2x8 Ah	2x9.4 Ah
<b>Battery recharge time</b>	6-8 hrs	6-8 hrs	6-8 hrs	6-8 hrs	6-8 hrs
<b>Runtime in minutes at typical load (60%)</b>	3'30"	2'30"	5' 51"	5' 08"	3' 01"
<b>Ambient temperature</b>	0-40°C	0-40°C	0-40°C	0-40°C	0-40°C
<b>Max rel.humidity</b>	0-90% not condensing	0-90% not condensing	0-90% not condensing	0-90% not condensing	0-90% not condensing
<b>Storage temperature</b>	-20 to 50°C	-20 to 50°C	-20 to 50°C	-20 to 50°C	-20 to 50°C
<b>Net weight</b>	6 kg	6.6 kg	8 kg	11.1 kg	11.9 kg
<b>Dimensions (WxHxD)</b>	100x142x330 mm	100x142x330 mm	146x200x392 mm	146x200x392 mm	146x200x392 mm

# PowerValue 11T G2

A cost-effective solution for maximum power protection



ABB's PowerValue 11T G2 is a single-phase in/out, double conversion online uninterruptible power supply (UPS) that guarantees up to 10 kW per single UPS of clean, reliable power for your critical single-phase applications. As well as maintaining power to your server room, advertising display, turnstiles, lab equipment, transportation signaling systems, ATM or vending machine, the PowerValue 11T G2 also conditions incoming power to eliminate spikes, swells, sags, noise and harmonics.

Featuring voltage and frequency independent (VFI) topology, the tower-only PowerValue 11T G2 saves costs by minimizing energy losses with its double

conversion efficiency of up to 95 percent (up to 98% in ECO mode). Two or three units can be connected in parallel to boost power delivery to a maximum of 30 kW or to provide redundancy.

Simple to install or maintain, inexpensive to run and with the most compact online UPS footprint available on the market, the PowerValue 11T G2 provides stable, regulated, transient-free, pure sine wave AC power with extremely tight output voltage regulation. All units can be fitted with up to four external battery modules (EBMs) to extend runtime to well over two hours. Each EBM is dedicated to its corresponding UPS and setup is easily accomplished via the LCD menu.

## High reliability

- Double conversion topology protects the load from all input disturbances
- Parallelable up to three units (6-10k only) to provide system redundancy
- User replaceable batteries
- Wide input voltage tolerance

## Low cost of ownership

- Scalable runtime
- High operating efficiency
- Low installation and upgrading costs
- Compact design
- Output power factor of 1.0 (6-10 kVA only)

## Flexible design

- Multiple connectivity options
- Each UPS can be connected with up to four parallel battery modules for extended runtime
- Adjustable DC voltage and battery charger current
- Extended backup time models available
- Best power density available in the market segment

## Efficient service concept

- Integrated manually operated maintenance bypass switch (6-10 kVA only)
- Easy setup and maintenance (plug and play)
- User-friendly display
- Remote monitoring options

# PowerValue 11T G2

## Product features

The PowerValue 11T G2 with its cost-effective ABB UPS technology makes a high-performance and is now available to market sectors with lower power requirements: Small server rooms, critical lab or industrial equipment, security installations and applications of a similar power class can now profit from one of 12 PowerValue 11T G2 models.

With the most compact online UPS footprint available, the PowerValue 11T G2 features true on-line double conversion. This provides a flexible output frequency and isolates the UPS from upstream disturbances so that the critical load sees only stable, well-regulated, transient-free, pure sine wave AC power.

A rated output power factor up to 1.0 (kVA = kW) means the PowerValue 11T G2 delivers 11 percent more active power than a UPS with a power factor of 0.9. The UPS is optimized for modern IT loads and

helps users reduce their energy budget with its double conversion efficiency of up to 95 percent (up to 98% in ECO mode).

- Low input line disturbances: input PF  $\geq$  0.995 @ 100 percent linear load – THDi < 3 percent
- Flexible configuration for scalable runtime: UPS and EBMs with and without batteries (long backup)
- Adjustable DC voltage and battery charger current
- Digital charger technology provides accurate charger current setting and reduces charger ripple current
- The UPS is delivered with an inbuilt parallel board and paralleling cables. No additional hardware is required for this installation.

All this with the same guaranteed high availability and quality standards as ABB's higher-power premium UPS models - and at the most attractive entry level price around.

## UPS configuration

### Standard

- Tower-type, IP20 UPS enclosure
- Single-phase in and out
- Online double conversion UPS
- Paralleling up to three units allows for increase of capacity to 30 kW or redundancy (6-10 kVA only)
- Operator and status LCD
- Wide voltage input frequency range
- Inbuilt batteries (B/B2 versions only)
- Maintenance bypass switch (6-10 kVA only)
- Plug-and-play

### Options

- Additional battery cabinets (EBM) for scaling autonomy time
- SNMP, ModBus and AS400 interface cards for remote control and monitoring of the UPS via a web browser
- Sensors – combined with the network interface card, environmental humidity and temperature sensors can be integrated into the system and monitored remotely
- Connectivity functionality via Winpower SNMP (network management card), mini SNMP, ModBus, mini ModBus, EMP (environmental monitoring probe), AS400 and mini AS400



# PowerValue 11T G2

## Available models

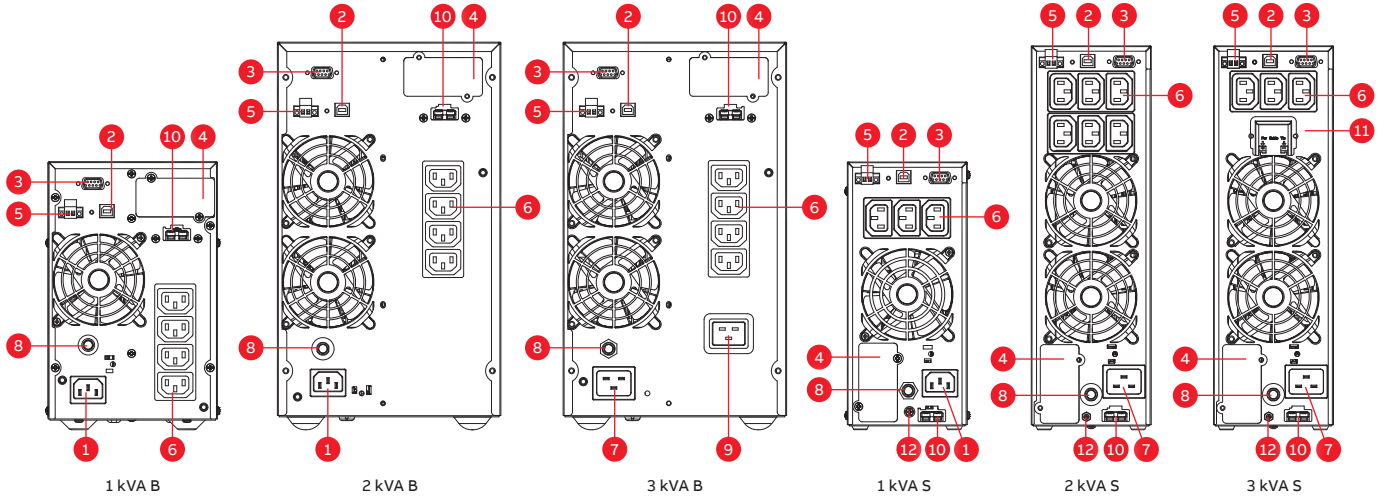

1. AC input 10 A	4. Mini SNMP/ Mini ModBus / Mini AS400	7. AC input 16 A	10. EBM connector
2. USB port	5. EPO / dry input	8. Output breaker	11. AC output 20 A
3. RS-232	6. AC output 10 A	9. AC output 16 A	12. GND contact

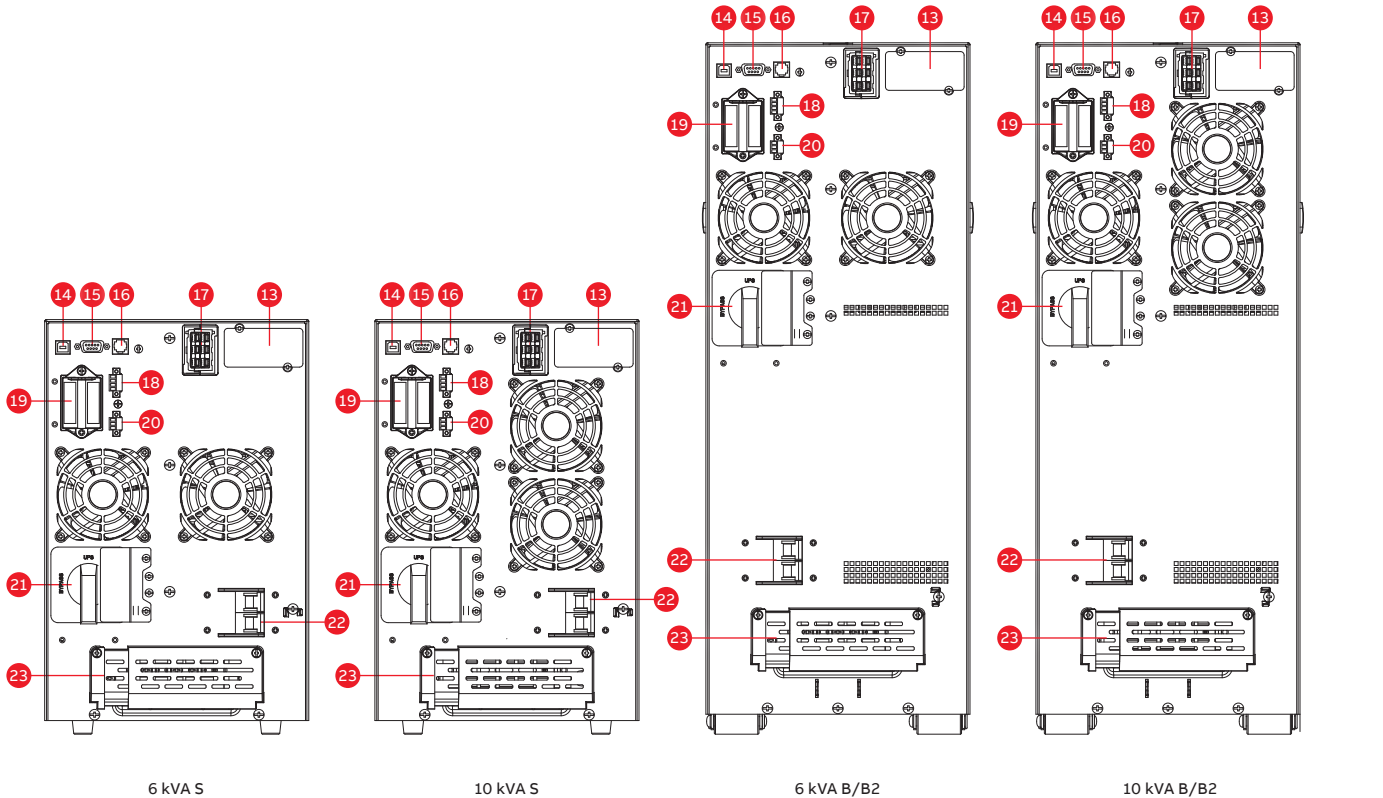

13. SNMP/ModBus/AS400	16. Reserved for future use	19. Parallel port	22. Input breaker
14. USB port	17. EBM connector	20. EPO	23. I/O terminals
15. RS-232	18. Dry in / out	21. MBP switch	

# PowerValue 11T G2

## Technical specifications

GENERAL DATA	G2 1kVA B/ S	G2 2kVA B/ S	G2 3kVA B/ S	G2 6kVA B/ B2 / S	G2 10kVA B/ B2 / S
Output rated power	900 W	1'800W	2'700W	6'000W	10'000W
Output power factor	0.9	0.9	0.9	1.0	1.0
Topology	Online double conversion				
Parallel configuration	No	No	No	Yes, up to 3 UPS	Yes, up to 3 UPS
Inbuilt batteries	Yes/No	Yes/No	Yes/No	Yes/Yes/No	Yes/Yes/No
<b>INPUT</b>					
Nominal input voltage	220/230/240 VAC			208/220/230/240 VAC	
Input voltage tolerance	100-300 VAC (load dependent)			100-276 (load dependent)	
Input current THDi	5% with full resistive load			<3% with full resistive load	
Frequency range	45-55 Hz / 54-66 Hz			45-55Hz / 54-66Hz (extendable to 40~70HZ at load < 60%)	
Power factor	≥0.99			≥0.995	
<b>OUTPUT</b>					
Rated output voltage	220/230/240 VAC			208/220/230/240 VAC	
Voltage tolerance	±1% (referred to 230V)				
Voltage distortion	<2% linear load, <6% non linear load			<1% linear load, <5% non linear load	
Overload capacity (linear load) on inverter	60s: 106-130% load 10s: 131-150% load 300ms: ≥ 150% load			10m: 102-125% load 30s: 126 to 150% load 500 ms: ≥ 150% load	
Nominal frequency	50 or 60 Hz				
Crest factor	3:1 (load supported)				
<b>EFFICIENCY</b>					
Overall system efficiency	Up to 89%	Up to 91%	Up to 91%	Up to 95%	
In eco-mode	Up to 97.5%	Up to 98%	Up to 98%	Up to 98%	
<b>ENVIRONMENT</b>					
Protection rating	IP20				
Storage temperature	UPS: -25°C to 60°C; Batteries: 0°C to 35°C				
Operating temperature	0°C to 40°C			0°-40°C (up to 50°C at 50% load)	
Relative humidity	0% to 95%				
Altitude (above sea level)	1000m without derating				
<b>BATTERIES</b>					
Type	VRLA (valve regulated lead-acid)				
Inbuilt batteries	2x9.4 Ah (B)	4x9.4Ah(B)	6x9.4Ah(B)	16x9Ah(B) 20x9Ah (B2)	16x9Ah(B) 20x9Ah (B2)
Charging current	1.5A/3-6A adjustable	1.5A/1.5-6A adjustable	1.5A/1.5-6A adjustable	0-4A adjustable (B,B2) 0-12 adjustable (S)	
Recharge time (inbuilt batteries)	4h to 90%				
<b>COMMUNICATIONS</b>					
User interface	LCD display				
Optional communication cards	SNMP;ModBus;AS400;Environmental monitoring sensor probe				
<b>STANDARDS</b>					
Safety	IEC/EN 62040-1				
EMC	IEC/EN 62040-2				
Performance	IEC/EN 62040-3				
Manufacturing	ISO 9001:2015, ISO 14001:2015, OHSAS 18001				
<b>WEIGHT, DIMENSIONS</b>					
Weight	9.2/3.9 Kg	17.4/6.4 Kg	22.7/6.4 Kg	50.9/58.8/13 Kg	55.2/65.2/15.2 Kg
Dimensions w x h x d	144x228x356 mm 102x228x346mm	190x327x399 mm 102x327x390 mm	190x327x399 mm 102x327x390 mm	B / B2: 225 x 589x 452 mm S: 225x 348 x 452 mm	B / B2: 225 x 589x 452 mm S: 225x 348 x 452 mm

# PowerValue 11 RT G2

## The single-phase UPS for critical applications



ABB's PowerValue11RT is a double-conversion online UPS that guarantees up to 10kVA of clean, reliable power for your critical single-phase applications. As well as maintaining power to your servers, point-of-sale terminals, workstation clusters, routers, switches, hubs and sensitive electronic equipment, the PowerValue11RT also conditions incoming power to eliminate spikes, swells, sags, noise and harmonics.

The PowerValue11RT can be used as a standalone UPS device or installed into a standard 19" rack configuration, with connectivity options available for each.

Three units of the 6 or 10kVA models can be configured in parallel to provide redundancy or to increase the systems total capacity up to 30 kW. All units can be fitted with up to four battery modules to extend runtime.

---

### High reliability

- Reliable double conversion topology protects load from all input disturbances
- Batteries can be added or replaced easily
- Reduced recovery time from discharge
- Redundant parallel operation available (6 and 10 kVA units)

### Low cost of ownership

- Unity power factor (kW = kVA)
- Scalable runtime
- High operating efficiency, regardless of loading
- Reduced installation and upgrading costs
- Compact design

### Flexible design

- Configurable in tower or rack-mount format
- Rotatable display
- UPS can be connected with up to four parallel battery modules for extended runtime
- Long backup models available
- Full set of accessories and connectivity options

### Efficient service concept

- Manually operated maintenance bypass switch (optional)
- Easy set up and maintenance (plug and play)
- User-friendly display
- Hot swap user-replaceable batteries



# PowerValue 11 RT G2

## Product features

### Scalable solution

The advanced system architecture guarantees that the user is able to select a system to match their needs. Scalable runtime and the easy introduction of additional batteries make the solution sustainable.

In addition, three PowerValue 11 RT G2 6 or 10 kW UPSs can be connected in parallel to increase total power or to add redundancy. The UPSs are delivered with an installed parallel board and paralleling cables. No additional hardware is required for a parallel installation.

### Easy installation and maintenance

Ease of installation and operation is guaranteed. The 1-3 kVA module is a plug-n-play device where all you need to do is to plug it in a wall socket to begin protection. The 6-10 kVA UPS only requires basic electronic competence to properly start up the unit.

Both models have a versatile orientation (rack or tower), just by rotating the display; for 1-3 kVA UPS this is as easy as pushing a button. Mechanical accessories for securing the installation in standard 19" racks or in a vertical position are included in each UPS.

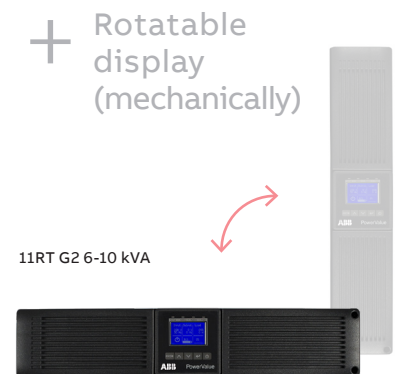
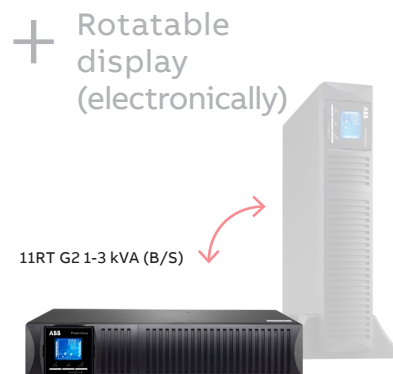

### Complete product offering

PowerValue 11RT G2 comes as a complete offering. For the range 1-3 kVA, B and S models are available. B models include internal batteries for basic runtime applications; however external battery modules (EBMs) can be plugged in to extend the system backup. S models have no internal batteries but a more powerful battery charger to support runtime-demanding applications; up to nine external battery modules (EBMs) or third-party battery packs (adapter included in the UPS) can be connected to form a personalized battery capacity.

The 6-10 kVA UPS integrates a max 12 A battery charger to withstand the most demanding scenarios and to support high-capacity battery extensions. A comprehensive set of accessories and options is available, too: External battery modules (EBMs), external maintenance bypass with PDU, 1U automatic transfer switch (ATS), rail kits for rack mounting, relay card with additional I/O potential-free contacts and full connectivity suite are available to complete the installation. Finally, optional yearly warranty extensions to the comprehensive basic warranty of three years allow peace of mind throughout the whole life cycle of the UPS

# PowerValue 11 RT G2

## Available models

1	AC input 10 A
2	USB port
3	RS-232
4	SNMP / AS400 slot
5	EPO / dry contact input port
6	Dry contact output port
7	AC output 10A
8	AC input 16A
9	AC input 20 A
10	AC output 16A
11	EPO
12	Parallel port
13	Dry in / out
14	MBP connector
15	Output breaker
16	I/O terminals
17	Input breaker
18	EBM connector

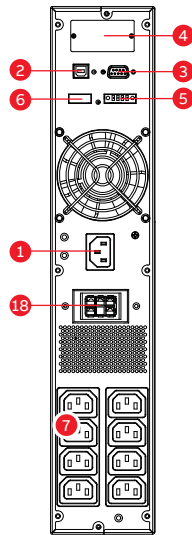

PowerValue  
11RT G2 1 kVA B/S

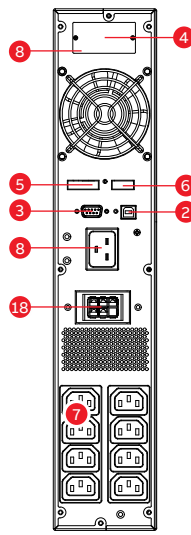

PowerValue  
11RT G2 - 2 kVA B/S

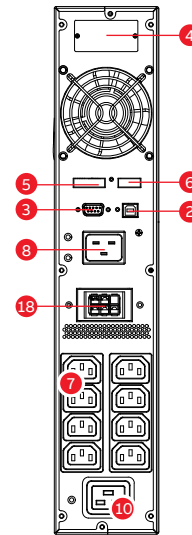

PowerValue  
11RT G2 - 3 kVA B

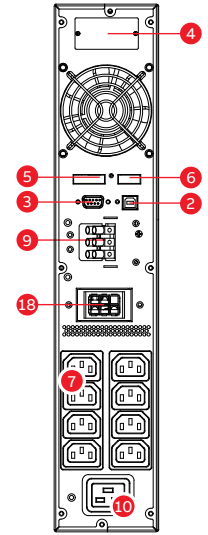

PowerValue  
11RT G2 - 3 kVA S

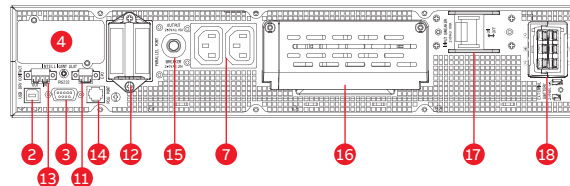

PowerValue 11RT G2 - 6-10 kVA

### Options

- Rack installation kit allows for easy mounting in standard 19" rack
- Full-range connectivity: SNMP, ModBus (RS-485 and TCP/IP), environmental monitoring probe, relay card with I/O contacts
- External maintenance bypass
- 1U automatic transfer switch (ATS) (PowerValue 11RT G2 1-3 kVA)
- High capacity external battery modules (EBMs) to scale up the system runtime (a plug-and-play cable included to connect UPS and other battery modules)

### UPS configuration

- Online double conversion UPS
- Unity power factor (kW = kVA)
- Efficiency in online mode up to 95%
- Efficiency in eco-mode up to 98%
- Configurable in tower format or rack-mount
- Three 6 kVA and 10 kVA UPSs (max 30 kW per system) can be connected in parallel for redundancy or extra capacity
- Cold start
- Frequency-converter operation (50 Hz or 60 Hz)
- Interfaces: USB, RS-232, potential-free contacts, EPO
- Load segmentation (for PowerValue 11RT G2 1-3 kVA)

# PowerValue 11 RT G2

## Technical specification

GENERAL DATA	1kW B/ S	2kW B/ S	3kW B/ S	6 kW	10 kW
Output rated power	1,000 W	2,000 W	3,000 W	6,000 W	10,000 W
Output power factor	1.0	1.0	1.0	1.0	1.0
Topology	Online double conversion				
Parallel configuration	No	No	No	Yes, up to 3 UPS	Yes, up to 3 UPS
Inbuilt batteries	Yes/No	Yes/No	Yes/No	No	No
<b>INPUT</b>					
Nominal input voltage	208/220/230/240 VAC				
Input voltage tolerance	120-300 VAC (load dependent)			100-276 (load dependent)	
Input current THDi	<5 % with full resistive load			<3 % with full resistive load	
Frequency range	45-55 Hz / 54-66 Hz			45-55 Hz / 54-66 Hz (extendable to 40~70 HZ at load < 60 %)	
Power factor	≥0.99			≥0.995	
<b>OUTPUT</b>					
Rated output voltage	208/220/230/240 VAC				
Voltage tolerance	±1 % (referred to 230V)				
Voltage distortion	< 2 % linear load, <5 % non-linear load			<1 % linear load, <5 % non-linear load	
Overload capacity (linear load) on inverter	60 s: 102-129 % load 10 s: 130-150 % load 300 ms: ≥ 150 % load			10 m: 102-125 % load 30 s: 126 to 150 % load 500 ms: ≥ 150 % load	
Nominal frequency	50 or 60 Hz				
Crest factor	3:1 (load supported)				
<b>EFFICIENCY</b>					
Overall system efficiency	Up to 92 %			Up to 95 %	
In eco-mode	Up to 98 %			Up to 98 %	
<b>ENVIRONMENT</b>					
Protection rating	IP20				
Storage temperature	UPS: -25 °C to 60 °C; batteries: 0 °C to 35 °C				
Operating temperature	0 °C to 40 °C				
Relative humidity	0 % to 95 %				
Altitude (above sea level)	1000 m without derating				
<b>BATTERIES</b>					
Type	VRLA (valve regulated lead-acid)				
Inbuilt batteries	2x9.4 Ah	4x9.4 Ah	6x9.4 Ah	-	-
Max charging current	1.5 A/6 A	1.5 A/6 A	1.5 A/6 A	0-12 A adjustable	
<b>COMMUNICATIONS</b>					
User interface	LCD				
Optional communication cards	SNMP; ModBus; AS400; Environmental monitoring sensor probe				
<b>STANDARDS</b>					
Safety	IEC/EN 62040-1				
EMC	IEC/EN 62040-2				
Performance	IEC/EN 62040-3				
Manufacturing	ISO 9001:2015, ISO 14001:2015, OHSAS 18001				
<b>WEIGHT, DIMENSIONS</b>					
Weight	11.4/5.8 kg	18.1/8.7 kg	27.9/9 kg	13.6 kg	15.5 kg
Dimensions w x h x d	438x86(2U) x309 mm	438x86(2U) x426 mm	438x86(2U) x629 mm	438x86(2U) x573 mm	438x86(2U) x573 mm

# PowerValue 11 / 31 T

The single-phase UPS for IT rooms, networks and other critical applications

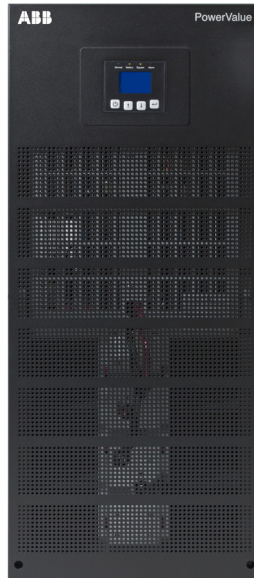

The PowerValue11/31T UPS delivers reliable power, low running costs, long battery life, easy maintenance and high levels of flexibility. Featuring double-conversion, voltage and frequency independent (VFI) topology, the PowerValue11/31T is available in both 10 and 20kVA versions, with the option to configure up to four units in parallel to boost power capability or provide redundancy.

Three-phase or single-phase inputs can also be accommodated, as well as single- or dual-supply inputs – allowing the customer to manage two independent power sources. Simple to install and with a small footprint, the PowerValue11/31T provides stable, regulated, transientfree, pure sine wave AC power with extremely tight output voltage regulation.

---

## High reliability

- Online double conversion topology
- Parallelable up to four units to provide system redundancy
- Programmed and automated battery tests ensure optimized battery management

## Low cost of ownership

- Simple power increase by paralleling up to four units
- High operating efficiency, regardless of loading
- Reduced installation costs
- Compact design

## Flexible design

- Different autonomy variations with inbuilt batteries or additional battery cabinets
- Long backup models available
- Single- or three-phase input – adaptable to installation requirements (field configurable)
- Single- or dual-input power source compatible (field configurable)

## Efficient service concept

- Integrated manual bypass switch
- Easy to install and maintain
- User-friendly display
- User-replaceable batteries
- Remote monitoring and connectivity options

# PowerValue 11 / 31 T

## Product features

### Compact power protection up to 80 kVA

PowerValue 11/31T 10 and 20 kVA UPS can be installed in parallel to increase the total system power up to 80 kVA or to add redundancy to the system. The UPSs are delivered with an inbuilt parallel board and paralleling cables. No additional hardware is required for this installation.

PowerValue 11/31T can be configured with up to two matching battery cabinets to satisfy extended runtime demands. Easily accessible and replaceable batteries increase availability and reduce mean time to repair (MTTR).

Up to 4 UPSs  
in parallel



Up to 2 battery  
cabinets in parallel

### Frequency conversion

Operating as a frequency converter, PowerValue 11/31T not only converts the power supply frequency (50 Hz to/from 60 Hz), but it also protects the load from power disturbances and guarantees additional battery power in case of mains failure.

The operation and installation is simple and consists merely of correctly wiring the UPS and selecting the frequency conversion mode in the LCD.

- Input frequency range: 40–70 Hz
- Output frequency: 50 Hz or 60 Hz
- Output derating:
  - Single-phase input: 60%
  - Three-phase input: no derating

# PowerValue 11 / 31 T

## Available models

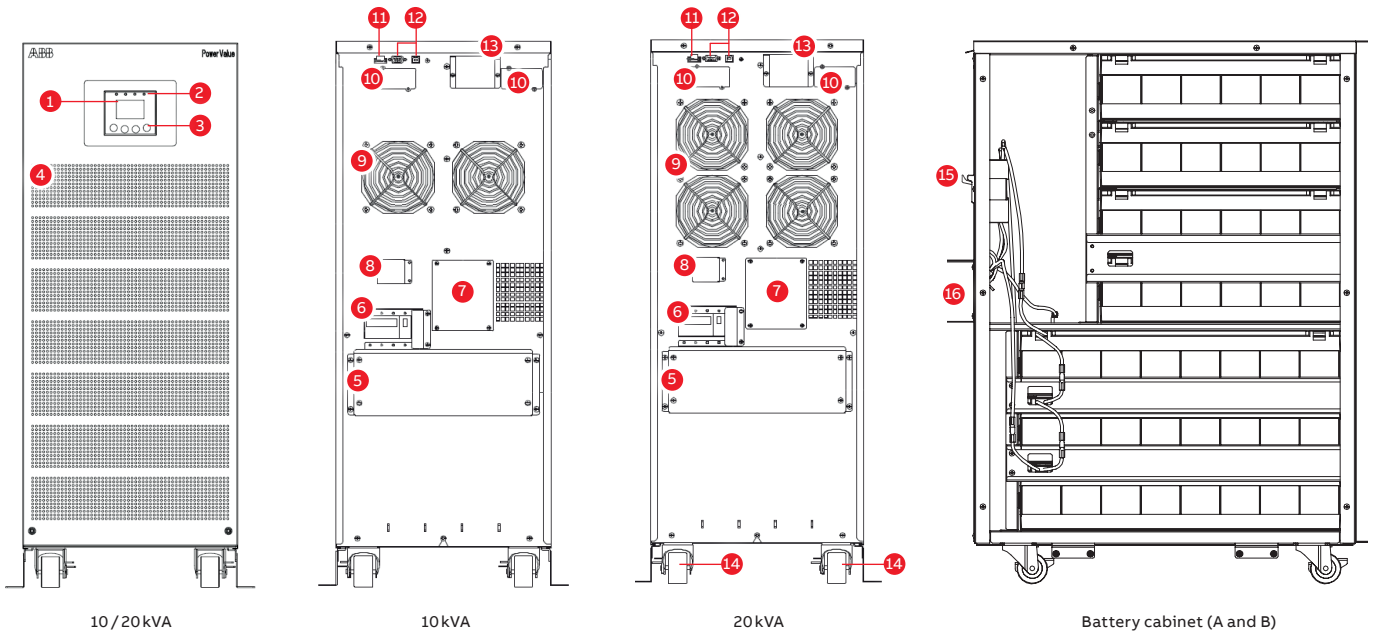

1 LCD	5 Connection terminals	9 Fans	13 Parallel port
2 LEDs	6 Input breaker	10 Network interface /AS400 slot	14 Wheels /support and brakes
3 Control keys	7 Manual bypass	11 EPO contact	15 Fuse holder
4 Ventilation inlets	8 Back-feed protection terminals	12 RS-232 port /USB port	16 Battery connection terminals

### UPS cabinet configuration

- Online double conversion UPS
- Efficiency in online mode up to 93.9%
- Efficiency in eco-mode up to 97%
- Paralleling up to four units allows for increase of capacity or redundancy
- Same model supports different wiring schemes
- Three-phase and single-phase input
- Single- and dual-input feed
- LCD
- Frequency converter operation (50Hz or 60Hz)
- Interfaces: USB, RS-232, ModBus, potential-free contacts, EPO contact inputs
- Emergency power-off for remote shutdown

### Options

- Dry-contact card – relay interface card enables advanced communication between the UPS systems
- Network interface cards – control and monitoring of the UPS via a web browser
- Sensors – combined with the network interface card, humidity and temperature sensors can be integrated into the system and monitored remotely
- Additional battery cabinets that match perfectly with the UPS for scaling autonomy time



# PowerScale 33

## The three-phase UPS for low power applications

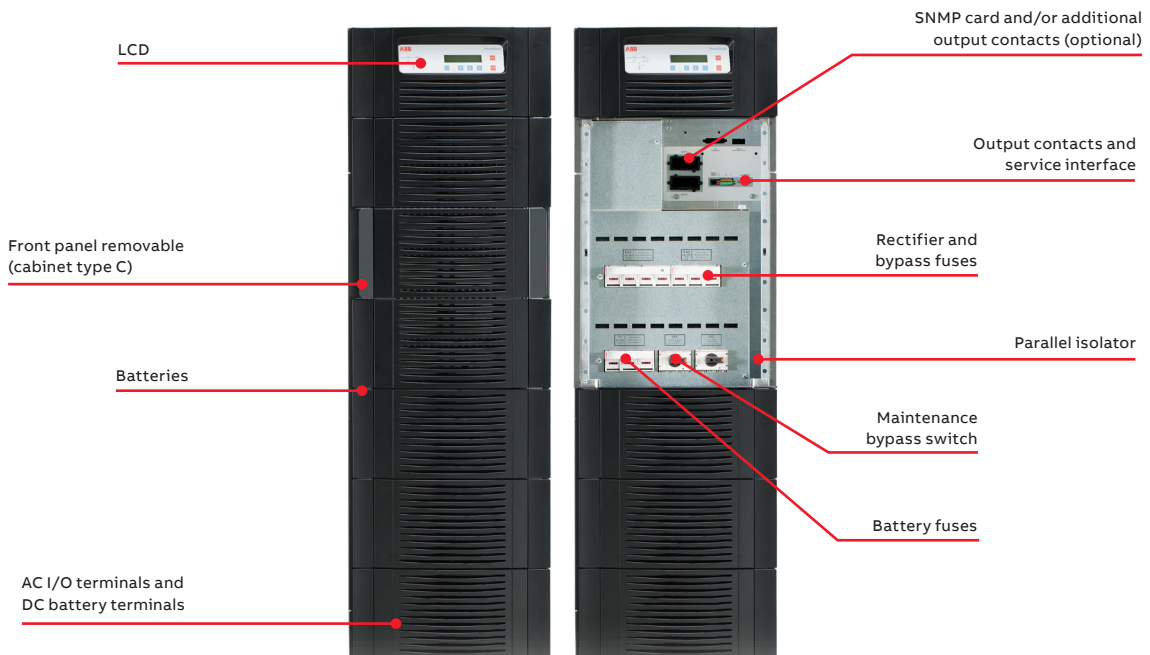

PowerScale 33 is an online, double-conversion, VFI (voltage frequency independent) UPS that provides enhanced power protection in a compact format. Its outstanding price/performance delivers the best value for money in its category with

uncompromised system reliability and power availability. PowerScale 33 is available in three cabinet sizes, enabling you to choose the ideal capacity and required autonomy for your critical load.

### High reliability

- Online double conversion technology
- Parallelable systems for increased redundancy

### Low cost of ownership

- Scalable power and autonomy time
- Small footprint/high power density
- High efficiency at partial and rated loads (up to 95.5%)
- Reduced installation costs
- Ripple-free and temperature controlled battery chargers extend battery life time performance
- Low input harmonic distortion (THDi <3%)

### Flexible design

- Available in seven power ratings and three cabinet sizes
- Parallel capacity up to 20 units
- External battery cabinets for extended autonomy

### Efficient service concept

- Manually operated maintenance bypass switch
- User-friendly LCD
- Ergonomic design for easy serviceability
- Remote monitoring and connectivity options



# PowerScale 33

## Available models

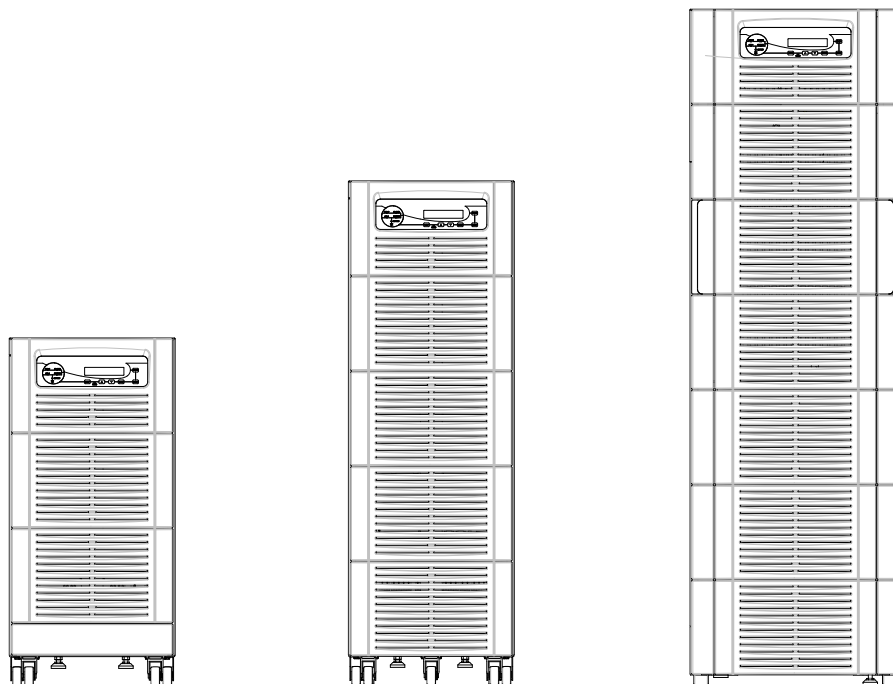

Cabinet type	Cabinet A: 10–20kVA	Cabinet B: 10–25kVA	Cabinet C: 25–50kVA
Dimension w × h × d	345 × 720 × 710 mm	345 × 1045 × 710 mm	440 × 1400 × 910 mm
Internal battery capacity	Up to 48 blocks 7 / 9Ah	Up to 96 blocks 7 / 9Ah	Up to 144 blocks 7 / 9Ah or 48 blocks 24 / 28Ah

### UPS cabinet configuration

- Online double conversion UPS
- Capacities from 10kVA to 50kVA in three different cabinet sizes
- Input, bypass and battery protection fuses
- Manual bypass switch
- Up to 95.5% efficiency across a wide load range
- Single- and dual-input feed available
- Communication interfaces: RS-232 and USB ports, I/O dry contacts (EPO, GEN On, ...)
- Free space to place internal batteries

### Options

- Integrated back-feed protection
- Parallel kit
- Cold start
- IP21
- Halogen-free cabling
- Battery temperature sensor
- Communication interfaces: Relay card, ModBus RS-485, ModBus TCP/IP, SNMP
- Internal batteries
- External battery cabinets

—

ABB's uninterruptible power supplies are the stars of the UPS stage. No other UPS offers your critical processes such a low cost of ownership or fuss-free operation. The pioneers and leaders in large, modular UPS offer you easily scalable and easily maintained UPSs that give unparalleled uptime and energy efficiency.



# PowerScale 33

## Technical specifications

General data	10kVA	15kVA	20kVA	25kVA	30kVA	40kVA	50kVA
Output power max.	9 kW	13.5 kW	18 kW	22.5 kW	27 kW	36 kW	45 kW
Output power factor	0.9						
Topology	Online double conversion						
Parallel configuration	Up to 20 units in parallel configuration						
UPS type	Standalone						
Inbuilt batteries	Yes						
<b>Input</b>							
Nominal input voltage	3×380V/220V+N, 3×400V/230V+N, 3×415V/240V+N						
Voltage tolerance (referred to ×400V/230V)	For loads <100% (-10%, +15%), <80% (-20%, +15%), <60% (-30%, +15%)						
Input distortion THDi	≤3 at 100% (sine wave)						
Frequency	35–70 Hz						
Power factor	0.99 at 100% load						
<b>Output</b>							
Rated output voltage	3×380 V/220 V+N, 3×400 V/230 V+N, 3×415 V/240 V+N						
Voltage tolerance (referred to ×400V/230V)	1% (static), 4% (dynamic)						
Voltage distortion	<2% linear load, <4% non linear load (IEC/EN62040-3)						
Frequency	50 Hz or 60 Hz						
Overload capability	5 min.:110 % or 20 sec.: 125 % (10 kVA - 25 kVA); 10 min.: 110 % or 1 min.: 125 % (30 kVA - 50 kVA)						
Unbalanced load	100% (all three phases regulated independently)						
Crest factor	3:1 (load supported)						
<b>Efficiency</b>							
Overall efficiency	Up to 95.5%						
In eco-mode configuration	98%						
<b>Environment</b>							
Storage temperature	-25°C to +70°C						
Operating temperature	0°C to +40°C						
Altitude	1000m without derating						
<b>Battery</b>							
Battery type	7 Ah/9 Ah/28 Ah, sealed, lead-acid, maintenance-free						
Battery replacement	Field-replaceable						
Battery voltage	Flexible voltage for longer backup times						
Battery capacity	48 or 96×7/9Ah	48 or 96×7/9Ah	48 or 96×7/9Ah	96 or 144×7/9Ah	144×7/9Ah or 48×28Ah	144×7/9Ah or 48×28Ah	144×7/9Ah or 48×28Ah
<b>Communications</b>							
LCD	Yes (per module)						
LEDs	LED for notification and alarm						
Communication ports	RS-232, SNMP slot (USB and potential-free contacts optional)						
<b>Standards</b>							
Safety	IEC/EN 62040-1						
Electromagnetic compatibility (EMC)	IEC/EN 62040-2						
Performance	IEC/EN 62040-3						
Product certification	CE						
Protection rating	IP20						
Manufacturing	ISO 9001:2015, ISO 14001:2015, OHSAS18001						
<b>Weight, dimensions</b>							
Cabinet type	A or B	A or B	A or B	B or C	C	C	C
Weight	60 or 88 kg	62 or 90 kg	64 or 92 kg	94 or 135 kg	145 kg	150 kg	155 kg
Dimensions w×h×d (mm)	345×720×710 or 345×1045×710	345×720×710 or 345×1045×710	345×720×710 or 345×1045×710	345×1045×710 or 440×1400×910	440×1400×910	440×1400×910	440×1400×910

# PowerWave 33

Efficient power protection for today's IT and process-related work environments



PowerWave 33, an online double conversion UPS, delivers continuous power availability to network-critical infrastructures of both data centers and process control environments. Offering maximum power protection, the PowerWave 33 has a small footprint and uses less energy than comparable products – thus delivering significant savings.

The PowerWave 33 is available over a model range of 60 kW to 500 kW and can be configured to operate as a single, standalone UPS or as a multi-cabinet UPS system with up to ten UPS cabinets connected in parallel, achieving a total power capacity of up to 5 MW.

## High reliability

- Online double conversion technology
- Parallelable systems for increased redundancy
- Extendable backup time
- Ripple-free and temperature controlled battery chargers extend battery life time performance

## Low cost of ownership

- Up to 96% efficiency in double conversion across a wide load range
- Up to  $\geq 99\%$  efficiency in eco-mode
- Rated output power factor 1.0
- Near-unity input power factor at partial and full loads

## Compact size

- Small footprint offers saving on expensive floor space
- Cooling air exhaust through the top of the cabinet – no rear cabinet clearance is required (only 60–120 kW and 400 to 500 kW units)

## Efficient service concept

- Front access for serviceability and maintenance
- User-friendly LCD
- Remote monitoring and connectivity options

# PowerWave 33

## Product features

01 The PowerWave 33 is available in various configurations.

02 As your power requirements grow, the UPS system grows with them – thanks to its scalability – even in the most confined spaces.



60–120 kW



160–200 kW



250–300 kW



400–500 kW

01

### Easily scalable for capacity and redundancy

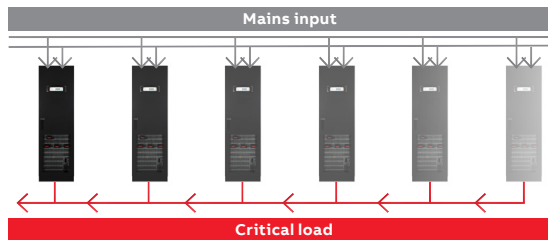

02

Up to 10 units can be configured in parallel to provide up to five megawatts of UPS power or redundant backup. This scalability means the UPS system capacity can be sized to match the load requirements, with the possibility to add incremental capacity later, when power needs change. The resulting savings in power usage over the service life of the UPS are substantial.

### Space-saving and simple to service

Space-saving mechanical design results in a power density of up to 363 kW/m<sup>2</sup> and front-to-top airflow allows installation directly against a wall (60–120 kW and 400–500 kW units). For service, only frontal access is needed, which means that the total footprint with maintenance clearances is minimized.

Optionally a top cable entry enclosure may be used for the 400–500 kW UPS. This enclosure permits the connection of all incoming power cables from the top and extends the overall width of the UPS by 500 mm.

### Well optimized for modern loads

A 1.0 rated output power factor means that each and every Watt of power is real power that is available for use. This helps with optimizing the complete electrical infrastructure in terms of switchgear and cabling, both upstream and downstream from the UPS.

Battery runtime can be optimized to match the exact needs. The UPS supports usage of 42–48 batteries (60–120 kW units) or 44–50 batteries (160–500 kW units) in a single string, which minimizes the total cost of installation as an optimal configuration can be used and so there is no need to oversize the battery.

### Mains-friendly with low input harmonics and advanced PFC

This UPS's front-end rectifier actively controls the input power factor and has extremely low input current harmonic content. This means that no additional filters are required upstream and the UPS does not cause any disturbance to other equipment connected to the same input source. Unity input power factor and low harmonic distortion allows upstream cabling, switchgear and generator sizes to be optimized, and reduces heating of input transformers.

# PowerWave 33

## Available models

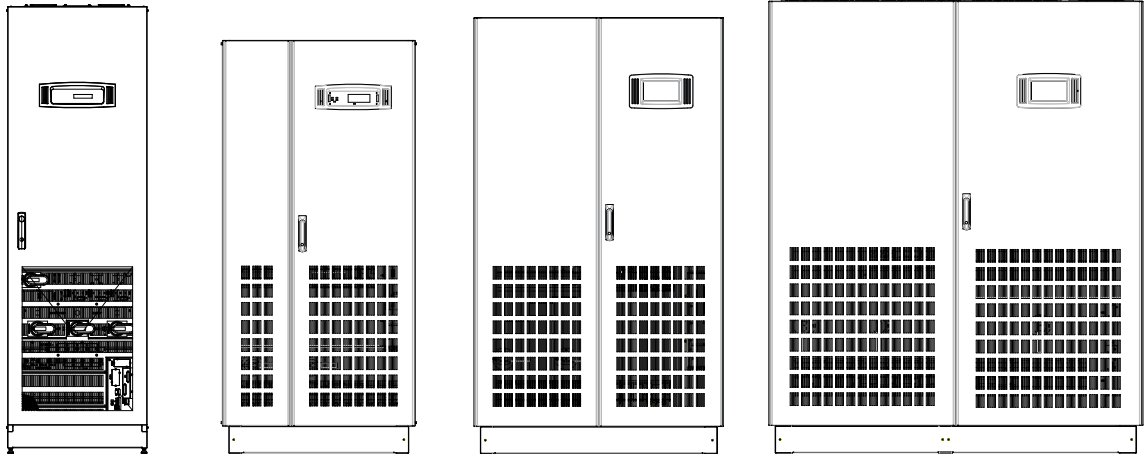

Cabinet type	60–120kW	160–200kW	250–300kW	400–500kW
Dimension w × h × d	615 × 1975 × 480mm	850 × 1820 × 750mm	1100 × 1920 × 750mm	1650 × 1994 × 850mm
Footprint	0.3m <sup>2</sup>	0.64m <sup>2</sup>	0.82m <sup>2</sup>	1.4m <sup>2</sup>

### UPS cabinet configuration

- Online double conversion UPS
- HMI interface with mimic diagram and LCD (60–200kW)
- Graphical touch screen display (250–500kW units)
- Input, bypass and battery protection fuses
- Manual bypass switch (optional for the units 400–500kW)
- Single- and dual-input feed available
- Communication interfaces: RS-232 port and 5 input dry contacts (incl. EPO and GEN On)

### Options

- Integrated back-feed protection
- Parallel system kit
- Synchronization kit
- Battery temperature sensor
- Remote panel (graphical touch screen display)
- Halogen-free cabling
- IP21
- Control and monitoring (relay card, ModBus RS-485, ModBus TCP/IP, SNMP)
- External battery cabinets
- Top cable entry enclosure (400–500kW units)

# PowerWave 33 60–120 kW

## Technical specification

General data	60kW	80kW	100kW	120kW
Output power max.	60kW	80kW	100kW	120kW
Output power factor	1.0			
Topology	Online double conversion			
Parallel configuration	Up to 10 units			
UPS type	Standalone			
<b>Input</b>				
Nominal input voltage	3× 380 / 220VAC + N, 3× 400 / 230VAC + N, 3× 415 / 240VAC + N			
Voltage tolerance (referred to 3× 400 / 230V)	For loads <100% (-10%, +15%), <80% (-20%, +15%), <60% (-30%, +15%)			
Input distortion THDi	≤4%			
Frequency	35–70 Hz			
Power factor	0.99			
<b>Output</b>				
Rated output voltage	3× 380 / 220VAC + N, 3× 400 / 230VAC + N, 3× 415 / 240VAC + N			
Voltage distortion	<2%			
Frequency	50 Hz or 60 Hz			
Overload capability	0.5 min.: 150% load / 5 min.: 125% load / 20 min.: 110% load			
Unbalanced load	100% (all three phases regulated independently)			
<b>Efficiency</b>				
Double conversion	Up to 96%			
In eco-mode configuration	≥99%			
<b>Environment</b>				
Storage temperature	-25 °C to +70 °C			
Operating temperature	0 °C to +40 °C			
Altitude configuration	1000m without derating			
<b>Battery</b>				
Battery type	Sealed, lead-acid, maintenance-free or NiCd			
<b>Communications</b>				
User interface	Optional			
Customer inputs	Remote shutdown, genset interface			
Customer outputs	Potential-free contacts (optional), USB (optional)			
<b>Standards</b>				
Safety	IEC / EN 62040-1			
Electromagnetic compatibility (EMC)	IEC / EN 62040-2			
Performance	IEC / EN 62040-3			
Product certification	CE			
Protection rating	IP 20			
Manufacturing	ISO 9001:2015, ISO 14001:2015, OHSAS18001			
<b>Weight, dimensions</b>				
Weight (without batteries)	198 kg	206 kg	228 kg	230 kg
Dimensions w × h × d	615 × 1954 × 480 mm or 615 × 1978 × 480 mm (with feet)			

---

Availability is everything when it comes to a UPS, so ABB's UPS architecture is designed to make sure that power is always available when you need it.





# PowerWave 33 160–500 kW

## Technical specification

General data	160kW	200kW	250kW	300kW	400kW	500kW
Output power max.	160kW	200kW	250kW	300kW	400kW	500kW
Output power factor	1.0					
Topology	Online double conversion					
Parallel configuration	Up to 10 units					
UPS type	Standalone					
Inbuilt batteries	Optional					
<b>Input</b>						
Nominal input voltage	3×380/220V+N, 3×400/230V+N, 3×415/240V+N					
Voltage tolerance (referred to 3×400/230V)	For loads <100% (-23%, +15%), <80% (-30%, +15%), <60% (-40%, +15%)					
Input distortion THDi	≤3.5%					
Frequency	35–70Hz					
Power factor	0.99					
<b>Output</b>						
Rated output voltage	3×380/220V+N, 3×400/230V+N, 3×415/240V+N					
Voltage distortion	<2%					
Frequency	50Hz or 60Hz					
Overload capability	1 min.: 135% load / 10 min.: 110% load					
Unbalanced load	100% (all three phases regulated independently)					
Crest factor	3:1 (load supported)					
<b>Efficiency</b>						
Overall efficiency	Up to 96%					
In eco-mode configuration	98%					
<b>Environment</b>						
Storage temperature	-25 °C to +70 °C					
Operating temperature	0 °C to +40 °C					
Altitude configuration	1000m without derating					
<b>Battery</b>						
Battery type	Sealed, lead-acid, maintenance-free or NiCd					
<b>Communications</b>						
Graphical display	Optional			Yes		
<b>Standards</b>						
Safety	IEC/EN 62040-1					
Electromagnetic compatibility (EMC)	IEC/EN 62040-2					
Performance	IEC/EN 62040-3					
Product certification	CE					
Protection rating	IP 20					
Manufacturing	ISO 9001:2015, ISO 14001:2015, OHSAS18001					
<b>Weight, dimensions</b>						
Weight (without batteries)	290kg	310kg	390kg	410kg	950kg	1000kg
Dimensions w × h × d	850 × 1820 × 750 mm		1100 × 1920 × 750 mm		1650 × 1994 × 850 mm	

# TLE Series IEC

## Clean, reliable power for your critical load

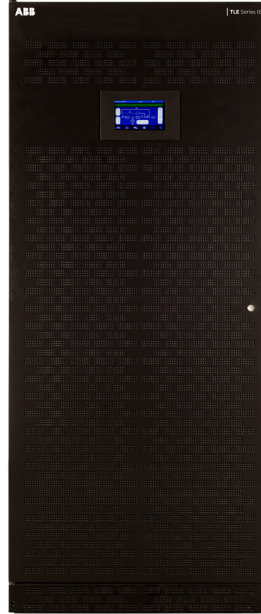

### ABB's TLE Series UPS 200-400 kW

The TLE Series is one of the best-performing three-phase UPS systems for providing critical power protection in a wide range of applications. The UPS operates in VFI (voltage frequency independent) mode and uses an innovative control algorithm with three-level converter technology to achieve very high efficiency levels. This innovative product provides best-in-class efficiency in both double conversion mode and in eBoost™

operating mode. The TLE Series UPS provides industry-leading reliability and efficiency, as well as clean power and unity power factor at the output. Reliability can be further increased by using ABB's unique RPA™ (redundant parallel architecture) technology to operate multiple units in parallel. Throughout their entire life cycle, all ABB UPS systems are fully supported by teams that provide training, application expertise and 24/7 preventive and corrective service.

---

#### High efficiency

- Efficiency of up to 96.6 percent in VFI mode and up to 98.3 percent in eBoost mode, reducing operational costs and minimizing energy losses
- The UPS ensures low current total harmonic distortion (THDi), ideal output voltage regulation and excellent dynamic response
- The UPS is optimized to provide high efficiency under part-load conditions

#### Low cost of ownership

- eBoost - available on 200-400 kW models - provides considerable additional energy cost savings over the lifetime of the UPS.
- ABB's RPA is a unique technology that allows a UPS to run in a parallel arrangement and with true redundancy by eliminating any single point of failure.

#### High performance and availability

- RPA for reliability, redundancy and scalability, offering up to six UPSs in parallel and power up to 2.4 MW
- Advanced control, monitoring and diagnostic capability, ensuring maximum performance of the UPS
- With unity output power factor, the TLE Series provides more output power.

#### Easy installation and configuration flexibility

- Intelligent energy management integrated operating mode maximizes efficiency at partial load by dynamically configuring the parallel UPS modules
- Variety of options for energy backup available, including lithium-ion batteries

# TLE Series IEC

## Product features

### Clean input performance

The TLE Series IGBT-based rectifier and innovative control algorithm ensure an input THDi of less than 3 percent and allow a pure sinusoid to be drawn from the mains. This arrangement also provides UPS input power factor of 0.99.

#### Advantages

Reduction in the size of upfront equipment eg, emergency generators, cabling, and circuit breakers  
No disturbance to nearby equipment; eliminates perturbation and outages on downstream electrical equipment, avoiding also any investigation and analysis costs arising from malfunction

### THDu

A distorted output voltage waveform affects the proper functioning of the load's equipment. The TLE Series has very low output voltage THD, even with 100 percent unbalanced or 100 percent nonlinear loads connected.

### TLE Series power capability

With unity output power factor, the TLE Series provides more output power. The output power factor diagram is symmetrical with respect to zero - no derating with any load. Suitable for modern power supply application with unity or capacitive power factor, crest factor up to 3:1

### Overload capabilities

The TLE Series UPS has a robust inverter capable of delivering 150 percent overload for 30 secs and 125 percent overload for 1 min, thus ensuring power protection continuity for applications requiring start-up overcurrent and for temporary peak loads.

### Short-circuit capability

The TLE Series inverter supplies 2.2 (for 100 ms) times the nominal current for ph-ph and ph-N/PE short circuits, respectively, ensuring the proper selectivity of the protection devices (fuses and breakers).

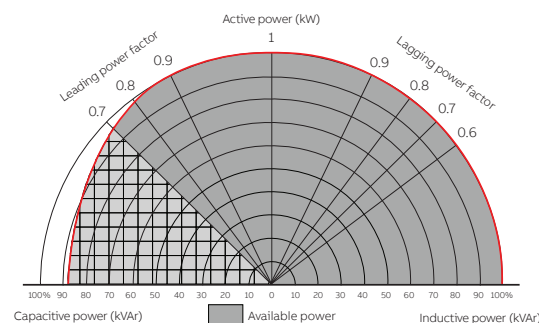

### Energy efficiency is our focus

eBoost provides considerable additional energy cost savings over the lifetime of the UPS. The savings become particularly significant for large energy users, such as data centers. With eBoost, organizations can reduce energy costs without sacrificing system reliability. Further details:

- $\eta$  = high efficiency, up to 99 percent
- Boost = fast transfer to inverter: < 2 ms
- Input voltage range:  $\pm 10$  percent
- Input frequency range:  $\pm 2$  percent
- Compliant with ITI (CBEMA) curve during transient events
- Patented power conditioning/filtering design via bypass inductor and output transformer/capacitor while in eBoost mode
- Battery trickle charge in eBoost operating mode

### Redundant parallel architecture (RPA)

RPA provides a scalable paralleling approach that reduces operating footprint and increases system reliability by eliminating the need for external paralleling equipment and cabinets (centralized bypass and master control). One UPS in the system intelligently takes the leadership role, while the other UPSs have access to all control parameters. If one UPS fails to operate, the load is automatically redistributed among the others.

# TLE Series

## Available models

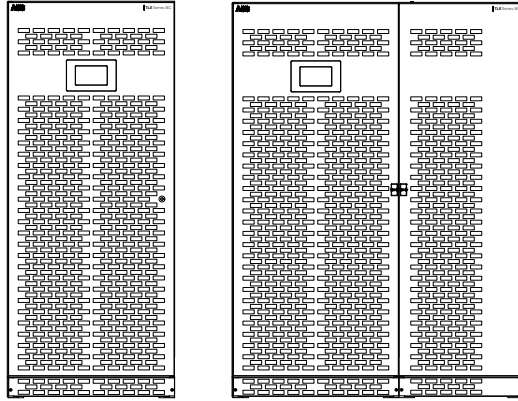

Cabinet type	200 kW	400 kW
Dimensions w x h x d (mm)	820 x 1905 x 865	1420 x 1905 x 865
Weight in kg (without battery)	500	980

### Key features

- eBoost, lithium batteries and RPA with intelligent energy management™ (IEM) further improve efficiency
- Input from mains conditioned to a sinusoid with 0.99 input power factor and <3 percent THDi
- Double conversion efficiency up to 96.6 percent
- Output power factor: 1
- True front access design
- Compact footprint
- Intuitive user interface
- Extremely low output voltage distortion
- Superior battery management

# TLE Series

## Technical specification

<b>General data</b>		
System power range	200 kW	400 kW
Active power / frame	200 kW	400 kW
Output power factor	<b>1.0</b>	
Topology	Online double conversion	
UPS type	Standalone tower	
Parallel configuration	Up to 6 units in parallel with redundant parallel architecture (RPA)	
<b>Input</b>		
Nominal input voltage	3 x 380/400/415 V + N	
Voltage tolerance	340-460 V	
Input distortion THDi	<3%	
Frequency	50/60 Hz	
Frequency range	45-66 Hz	
Power factor	>0.99	
Walk-in /soft start	Yes	
<b>Output</b>		
Rated output voltage	3 x 380/400/415 V + N	
Voltage tolerance	+/-1% static, +/-3% dynamic, +/-3% unbalanced load	
Voltage distortion THDU	<2.5% linear load, <5% nonlinear load (EN 62040)	
Frequency	50/60 Hz	
Overload capability (at 25 C environmental temperature)	150% 30 s, 125% 1 min, 100% 10 min, 105% continuous	
Output short-circuit capability	2.2*In (Ph-N/PE and Ph-Ph)	
Crest factor	>3:1	
<b>Efficiency</b>		
Overall efficiency	Up to 96.6%	Up to 96.6%
In eco-mode (eBoost) configuration*	Up to 98.3%	Up to 98.3%
<b>Environment</b>		
Storage temperature	UPS: -25° C +55° C	
Operating temperature	0-40° C	
Humidity	Max. 95% (non-condensing)	
Altitude configuration	Up to 1000 m with no de-rating, at 1500 m:-2.5%/ 2000 m:-5%/ 2500 m:-7.5%/ 3000 m:-10% (EN/IEC 62040-3)	
<b>Communications</b>		
HMI	Multilingual graphic display (LCD)	
Relay contractors	6 voltage-free contacts for 27 programmable alarms	
Input signals	EPO, Gen-ON (emergency power supply ON, n/o contact), 1 auxiliary signal (settable functionality)	
Communication ports	RS232, SNMP (Modbus IP, RS232, RS485 & BacNet IP)	
<b>Electrical / mechanical</b>		
Degree of protection	IP20	
Color	RAL 9005 (black)	
Cable entry	Top/bottom (top optional only for 160-200 kW)	
Back-feed protection	Built-in as standard	
Serviceability	Fully front serviceable	
Ventilation	From front to top	
<b>Batteries</b>		
Type	VRLA batteries, vented lead-acid batteries, wet batteries, NiCd, flywheel, Li-Ion	
DC floating voltage	545-600 V	
<b>Standards</b>		
Safety	IEC / EN 62040-1	
Electromagnetic compatibility (EMC)	IEC / EN 62040-2	
Performance	IEC / EN 62040-3	
Product certification	CE marking	
Manufacturing	ISO 9001	
<b>Weight, dimensions</b>		
Weight (kg)	500	980
Dimensions w x h x d (mm)	820 x 1905 x 865	1420 x 1905 x 865

\* Optional feature for all available models

# SG Series IEC

## Reliable and efficient standalone UPS for critical applications

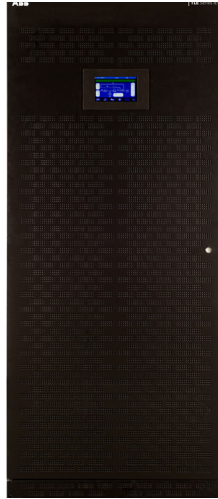

The SG Series is one of the best performing, most reliable and most versatile three-phase UPS systems available to those who need critical power protection. This true online double conversion UPS exploits its network integration software and communication connectivity to provide comprehensive, easy-to integrate power protection for almost any IT environment. The SG Series operates in VFI-mode, which maximizes load protection at any time. Instead of standard filters, the UPS runs an innovative control algorithm on the

IGBT rectifier to ensure the delivery of clean power in a most efficient manner.

ABB's unique RPA™ technology (redundant parallel architecture) allows units to work in parallel, thus further increasing reliability and uptime. Through their complete life cycle, all ABB UPS systems are fully supported by service teams that provide world-class, 24/7 preventive and corrective services, training and application expertise.

### High efficiency

- Up to 94.6 percent in double conversion mode and up to 99 percent in eBoost mode
- eBoost operation minimizes losses and can save annual power and cooling costs
- The PurePulse IGBT rectifier keeps your supply network clean and compact by shrinking the circuit breaker, cabling and generator

### Low cost of ownership

- Optimal performance for a wide range of power
- Excellent dynamic response in case of pulsating load
- Scalable paralleling technique reduces operating footprint and increases system reliability by eliminating the need for external paralleling equipment

### High performance and availability

- Enhanced output performance that protects and supplies even the most sensitive IT loads with a lagging-leading power factor (0.9) without derating
- Excellent dynamic performance and low output voltage distortion
- Inverter zig-zag isolation transformer provides outstanding short-circuit capability and load galvanic separation

### Easy installation and configuration flexibility

- True front access for operation and maintenance
- reduces mean time to repair (MTTR)
- The redundant parallel architecture delivers reliability, redundancy and scalability
- Up to six UPS frames can be paralleled

# SG Series IEC

## Product features

### Input performance

#### PurePulse™ - IGBT rectifier clean input

PurePulse is an innovative control algorithm applied to the IGBT rectifier (available for models from 10 to 500 kVA). This current source rectifier assures an input total harmonic distortion (THDi) of less than 2 percent at full and partial loads and draws a pure sinusoidal waveform from the mains.

#### Robust rectifier for a wide input range

The wide AC input voltage and frequency window avoids unnecessary battery discharge even when operating from an unstable AC source (for example, a diesel generator).

#### Programmable soft start

The programmable soft start allows the rectifier to ramp up in a programmable period (0-15 s), thus eliminating inrush current. This feature reduces the need to oversize the input power system (gensets, feeder cables and overcurrent devices).

### Output performance

#### THDU

The SG Series has very low output voltage THD, even with 100 percent unbalanced or 100 percent nonlinear loads connected.

#### Overload capabilities

The SG Series UPS has a robust inverter capable of delivering 150 percent overload for 1 min and 125 percent for 10 min, thus ensuring power protection continuity for applications requiring start-up overcurrent and for temporary peak loads.

#### Voltage regulation

Because the SVM and the zig-zag transformer enable the inverter to react very quickly under step-load conditions, the UPS has very tight voltage regulation during step loads and 100 percent phase-to-neutral (Ph-N) load imbalances.

#### Short-circuit capability

The SG Series inverter supplies 2.7 and 4.0 times (for 200 ms) the nominal current for ph-ph and ph-N/PE short-circuit respectively, ensuring the proper selectivity of the protection devices (fuses and breakers).

#### Zig-zag output transformer

The zig-zag transformer enables the UPS to run with heavily unbalanced loads while supplying full kVA output capacity at 100 percent nonlinear load.

#### SG Series power capability

- No derating required to supply resistive and capacitive loads (0.9)
- Suitable for modern power supply application with unity or capacitive power factor, crest factor up to 3:1



# SG Series

## Available models

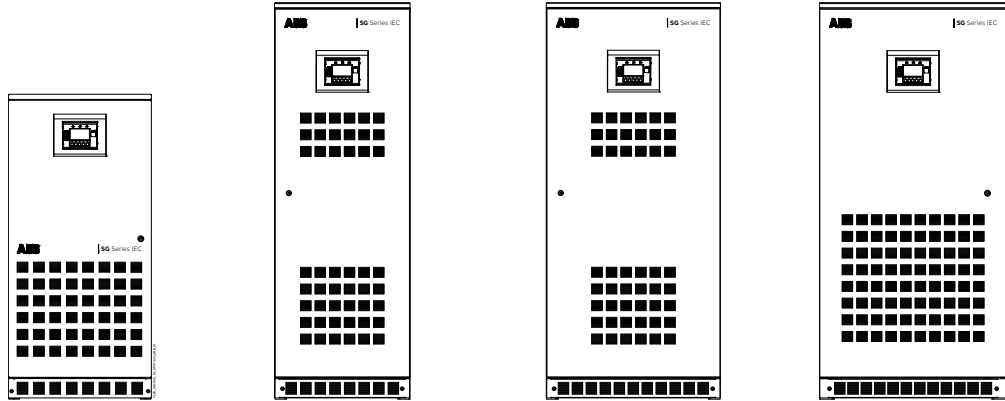

Cabinet type	10 - 40 kVA	60 - 80 kVA	100 - 120 kVA	160 kVA
Dimensions w x h x d (mm)	680 x 1450 x 800	650 x 1900 x 850; 835 x 1900 x 850	835 x 1900 x 850	900 x 1900 x 850
Weight in kg (without battery)	290 - 420	550 - 630	860	1050

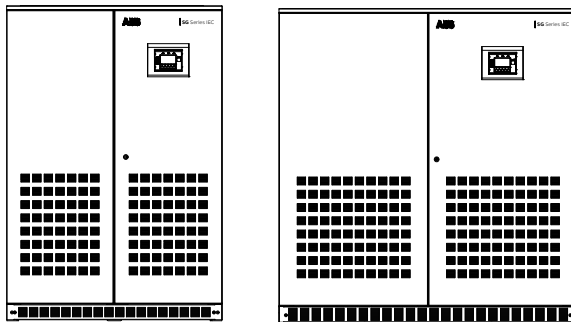

Cabinet type	200 - 300 kVA	400 - 500 kVA
Dimensions w x h x d (mm)	1300 x 1900 x 850	1800 x 1900 x 950
Weight in kg (without battery)	1220 - 1560	2190 - 2470

### Key features

- eBoost technology for high efficiency - up to 99 percent
- Up to 94.6 percent efficiency
- PurePulse IGBT rectifier: clean input <2 percent THDi
- Output power factor: 1.0 (10-40 kVA), 0.9 (60-600 kVA)
- True front access design
- Small footprint
- Inverter zig-zag isolation transformer
- Extremely low output voltage distortion
- Superior battery management
- Intelligent energy management integrated (IEMi)
- Backfeed protection
- Built-in maintenance bypass
- Parallelable up to six units



# SG Series

## Technical specification

<b>General data</b>						
System power range	10 – 40 kVA	60 – 80 kVA	100 – 120 kVA	160 kVA	200 – 300 kVA	400 – 500 kVA
Active power / frame	10/15/20/30/40 kW	54 / 72 kW	90 / 108 kW	144 kW	180/ 225 / 270 kW	360 / 450 kW
Output power factor	0.9 lead – 0.6 lag					
Topology	Online double conversion					
UPS type	Standalone, transformer-based					
Parallel configuration	Up to 6 units in parallel with Redundant Parallel Architecture (RPA)					
<b>Input</b>						
Nominal input voltage	3 x 380/400/415 V + N					
Voltage tolerance	340-460 V					
Input distortion THDi	<3%					
Frequency	50/60 Hz					
Frequency range	45-66 Hz					
Power factor	>0.99					
Walk-in / soft start	Yes					
<b>Output</b>						
Rated output voltage	3 x 380/400/415 V + N					
Voltage tolerance	+/-1% static, +/-3% dynamic, +/-3% unbalanced load					
Voltage distortion THDU	<2% linear load, <3% nonlinear load (EN 62040)					
Frequency	50/60 Hz					
Overload capability	150% 1 min, 125% 10 min					
Output short circuit capability	2.7*In(Ph-N) / 4*In(Ph-Ph) for 200 ms					
Crest factor	<3:1					
<b>Efficiency</b>						
Overall efficiency	Up to 92.3%	Up to 91.9%	Up to 92.1%	Up to 94.2%	Up to 94.6%	Up to 94.2%
In eco-mode (eBoost) configuration	Up to 98%	Up to 97.9%	Up to 97.9%	Up to 98.4%	Up to 98.5%	Up to 98.7%
<b>Environment</b>						
Storage temperature	UPS: -25 °C +55 °C					
Operating temperature	0-40 °C					
Humidity	Max. 95% (non-condensing)					
Altitude configuration	Up to 1000 m with no derating, at 1500 m:-2.5%/ 2000 m:-5%/ 2500 m:-7.5%/ 3000 m:-10% (EN/IEC 62040-3)					
<b>Communications</b>						
HMI	Multilingual graphic display (LCD)					
Relay contractors	6 voltage-free contacts for 27 programmable alarms					
Input signals	EPO, Gen-ON (emergency power supply ON, n/o contact), 1 auxiliary signal (settable functionality)					
Communication ports	RS232, SNMP (Modbus IP, RS232, RS485 & BacNet IP)					
<b>Electrical / Mechanical</b>						
Degree of protection	IP20					
Color	10-120 kVA RAL 9003 (white), 160-500 kVA RAL 9005 (black)					
Cable entry	Bottom (top optional)					
Back-feed protection	Built-in as standard					
Serviceability	Fully front serviceable					
Ventilation	From front to top					
Audible noise	<65 dB(A)	63 dB(A)	63 dB(A)	69 dB(A)	69 dB(A)	69 dB(A)
<b>Batteries</b>						
Type	VRLA batteries, vented lead-acid batteries, wet batteries, NiCd, flywheel					
DC floating voltage	409-436 V					
<b>Standards</b>						
Safety	IEC / EN 62040-1					
Electromagnetic compatibility (EMC)	IEC / EN 62040-2					
Performance	IEC / EN 62040-3					
Product certification	CE marking					
Manufacturing	ISO 9001					
<b>Weight, dimensions</b>						
Weight (Kg)	290-420	550-630	860	1050	1220-1560	2190-2470
Dimensions w x h x d (mm)	680x1450x800	650x1900x850	835x1900x850	900x1900x850	1300x1900x850	1800x1900x950

# Xtra VFI

## Double conversion mode maximizes efficiency under low-load conditions

01 Superior double conversion efficiency helps to decrease costs of operation. The Xtra VFI feature boosts efficiency when the UPS operates with low load compared to nominal capacity.

02 Conceptpower DPA 500 in Xtra VFI operating mode as reference example

Under operating conditions where the load is low compared to UPS total capacity, efficiency typically suffers and relative power losses are increased. Under these conditions, by using Xtra VFI – double conversion mode, ABB's DPA 250 S4 and Conceptpower DPA 500 can step up the system efficiency by optimizing the number of modules used in double con-

version mode to feed the load. In case of a load step, more modules are switched automatically in milliseconds to online mode to secure the critical load.

The figure below shows how the Xtra VFI operating mode can enhance efficiency when running at a low load level for a DPA 250 S4 system.

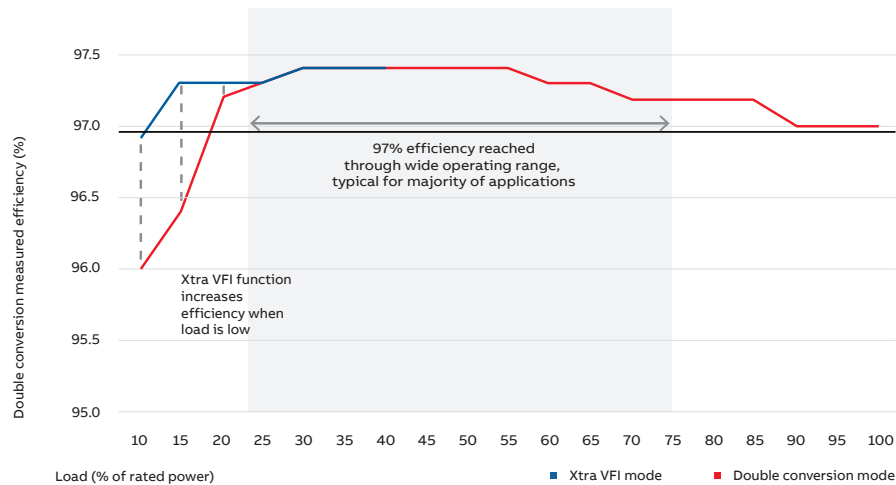

01

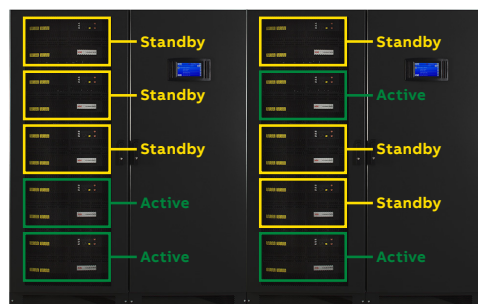

02

### □ Active

The UPS module is operating in double conversion mode and supplying the load with other active modules. Loading of the module is equal to full load divided by number of active modules.

### □ Standby

The UPS module is on standby mode, ready to kick in and transfer to active double conversion mode in case needed. Response time for the module to transfer to active mode is in the range of milliseconds.

### Control and metering via graphical interface

Xtra VFI has an interface that allows the user to set up operating parameters to suit the particular application.

Customer-configurable parameters include:

- How many redundant modules should be active at any time
- The highest expected load step (in kW or %).

This allows the system to further optimize the UPS performance and efficiency

The system calculates and displays Xtra VFI energy savings, etc. compared to normal operation:

- Instantaneous power (kW) currently being saved by the Xtra VFI mode
- The cumulative energy (kWh) saved from the day Xtra VFI mode was first enabled
- The number of modules in active mode and on standby
- A Xtra VFI preview in the display menu can be used to simulate how much power would be saved with different Xtra VFI setups

# Tested and trusted

## The test center at a glance

—  
01 The modular infrastructure enables flexible testing of up to 4 MW.

—  
02 Customers can monitor the entire test process from the comfort of the attached conference room, which has large windows that overlook the test bays. The teleconference and video sharing facilities allow customers who are further away to join in remotely.

Comprehensive testing is crucial. Therefore, companies usually test individual products before they leave the factory. However, out in the field, real life often throws up unexpected operating conditions once devices are assembled into a larger system.

That is why ABB has built a facility to test even the largest UPS configurations as one entity. The facility is designed to accommodate extended UPS systems – including, for example, energy storage such as battery banks, and input and output switchgear. ABB's test capabilities allow us to address trends toward bigger, more power-hungry data centers and industrial plants that require ever-larger UPS systems.

Full test capabilities:

- The modular infrastructure enables flexible testing of one 4 MW system or two smaller systems.
- The UPS can be tested together with associated equipment – such as switchgear, static transfer switches, transformers etc. – so the whole system can be quickly and smoothly integrated into the power infrastructure onsite.
- The test center can handle UPS systems for small- and medium-sized applications, as well as for power-hungry data centers and industrial plants.
- Different countries have different voltage standards – 208, 400, 480 VAC – and they can all be tested here.
- Customers and ABB engineers have a safe environment from which they can closely monitor the entire test process.
- As well as direct visual access, measurements from the test bays are displayed in the conference room.
- The facility is fully equipped with teleconference and video services to allow customer participation from anywhere on the planet.
- Around 90 percent of the power used in testing is recirculated. This massively reduces the electrical energy that is pulled from the public grid.

01

02



# Battery cabinets and accessories

## Extendable runtime

ABB offers a line of battery cabinets for its modular and standalone UPS series. These battery cabinets with integral overcurrent protection are compatible with a wide range of battery configurations and are optimized to meet application runtime needs.

The user may proceed as following to select the most appropriate battery cabinet and configuration:

1. Select UPS power and type
2. Choose common or separate battery configuration (in case of modular UPS)
3. Define backup time required
4. Select compatible and most appropriate battery cabinet
5. Calculate battery configuration using the ABB BAC autonomy calculator\*

\*Always verify the correct number of battery blocks according to the UPS model and battery cabinet specifications. Only even numbers of battery blocks are supported. 40 or 50 units per string are the most recommended configurations.

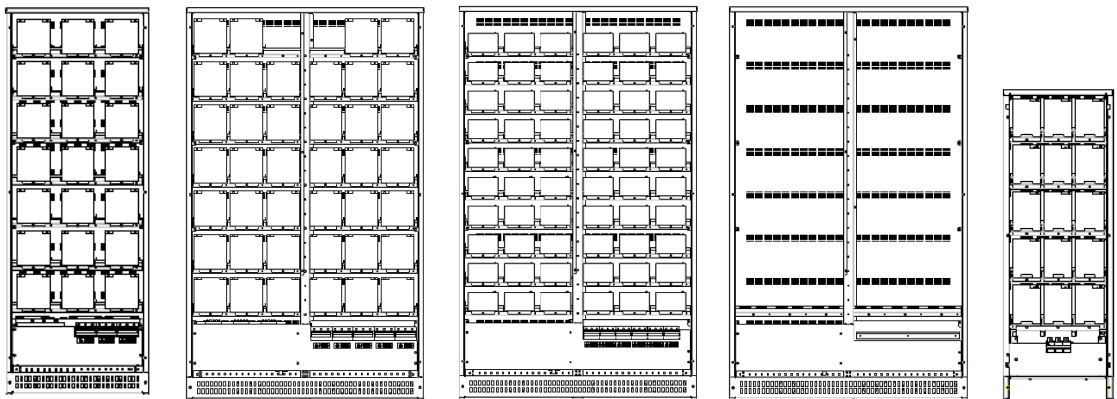

### Available models

Type	CBAT -120	CBAT- 200	CBAT- 600 S	CBAT-FLEX	CBAT- 88
------	-----------	-----------	-------------	-----------	----------

# Battery cabinets

## Technical specification

General data					
<b>Type</b>	CBAT -120	CBAT- 200	CBAT- 600 S	CBAT-FLEX	CBAT- 88
<b>Version</b>	CBAT- 120 S CBAT- 120 C	CBAT -200 S CBAT- 200 C	CBAT- 600 S	CBAT-FLEX	CBAT- 88
<b>Battery arrangement: common/separate</b>	Separate (S) Common (C)	Separate (S) Common (C)	Separate (S)	Not applicable	Common (C)
<b>Compatible UPS types</b>	Conceptpower DPA 150 kVA Conceptpower DPA 250 kVA  DPA UPScale ST 80 DPA UPScale ST 120  PowerWave 33 S2 160kW (only common)	Conceptpower DPA 150 kVA Conceptpower DPA 250 kVA  DPA UPScale ST 80 DPA UPScale ST 120 DPA UPScale ST 200 DPA 250 S4  PowerWave 33 S2 160kW (only common) PowerWave 33 S2 200kW (only common) PowerWave 33 S2 250kW (only common) PowerWave 33 S2 300kW (only common)	DPA UPScale ST 120	Conceptpower DPA 150 kVA Conceptpower DPA 250 kVA  DPA UPScale ST 80 DPA UPScale ST 120 DPA UPScale ST 200  PowerWave 33 S2 160kW (only common) PowerWave 33 S2 200kW (only common) PowerWave 33 S2 250kW (only common) PowerWave 33 S2 300kW (only common)	PowerScale 25kVA Cab C* PowerScale 30kVA Cab C* PowerScale 40kVA Cab C* PowerScale 50kVA Cab C*
<b>Max number of UPS modules (applies only to separate batt. configurations)</b>	3	5	6	-	-
Battery					
<b>VRLA battery type</b>	24/28Ah	24/28Ah	7/9Ah	Not Available	24/28Ah
<b>Battery dimensions w x h x d</b>	166 x 175 x 125 mm	166 x 175 x 125 mm	151 x 100 x 65 mm	Depends on batt. type	166 x 175 x 125 mm
<b>Maximum number of battery blocks</b>	120	200	600	Depends on batt. type	88
<b>Number of batteries per string (only even)</b>	30 – 50	30 – 50	30 – 50	Depends on batt. type	20 - 44
<b>Maximum number of battery strings</b>	3	5	12	Depends on batt. type	2
<b>Battery placement</b>	On trays	On trays	On trays	On shelves	On trays
<b>Battery per tray</b>	5	5	10	Depends on batt. type	5
<b>Number of trays</b>	24	40	60	Not Applicable	18
Electrical characteristics and wiring connection					
<b>Nominal DC voltage</b>	360–600V	360–600V	360–600V	Not applicable	240–528V
<b>DC fuse</b>	9×100A	15×100A	18×50A	Not available	3 ×100A
<b>Wiring terminal type</b>	S type: Terminals C type: Busbar	S type: Terminals C type: Busbar	Terminals	Not available	Terminals
<b>Wiring terminals</b>	S type: 3 x 3 x 50mm <sup>2</sup> + PE 1 x (2 x M8) C type : 3 x (2 x M8) + PE 1 x (2 x M8)	S type: 3 x 5 x 50mm <sup>2</sup> + PE 1 x (2 x M8) C type : 3 x (4 x M10) + PE 1 x (2xM8)	S type: 3 x 6 x 35mm <sup>2</sup> + PE 1 x (2 x M8)	Not included	3 x 25mm <sup>2</sup> + PE 1 x 25 mm <sup>2</sup>
Physical characteristics					
<b>Dimensions w x h x d</b>	730×1975×796mm	1200×1975×796mm	1200×1975×796mm	1200×1975×796mm	475×1400×940mm
<b>Weight with trays w/o batteries</b>	280 kg	390 kg	450 kg	w/o trays 190kg; weight of one shelf 15kg	140 kg
<b>Weight with trays and batteries</b>	Approx. 1480 kg	Approx. 2390 kg	Approx. 2010 kg	Depends on batt. type	Approx. 1040 kg
<b>Feet</b>	4 feet of 12,5 cm <sup>2</sup> each	6 feet of 12,5 cm <sup>2</sup> each	6 feet of 12,5 cm <sup>2</sup> each	6 feet of 12,5 cm <sup>2</sup> each	4 feet of 12,5 cm <sup>2</sup> each
<b>Color</b>	RAL 9005 - black	RAL 9005 - black	RAL 9005 - black	RAL 9005 - black	RAL 9005 - black
Options					
<b>Cables (UPS to batt.cabinet)</b>	4 m length, 10-150mm <sup>2</sup>	4 m length, 10-150mm <sup>2</sup>	4 m length, 10 mm <sup>2</sup>	Not available	4 m length, 25mm <sup>2</sup>

\* Only if no internal batteries

---

When you want power protection for a data center, production line or any other type of critical process, lithium-ion battery solutions provide peace of mind and the performance you need.



# Lithium-ion battery system for ABB UPS solutions

## Overview of ABB lithium-ion battery system

Lithium-ion battery system employs the very latest in battery technology and directly addresses the two top concerns of critical power users: availability and total cost of ownership. The system is a perfect fit for a wide range of ABB's UPS solutions. Working together, an ABB UPS and lithium-ion battery system provides users with the peace of mind that their applications are protected by the very best in power protection technology and they can be assured a constant flow of clean power.

The ABB lithium-ion battery solution is accommodated in a standard 19" cabinet. All connectors are front-facing for ease of installation, maintenance and replacement. A single cabinet configuration of 34.6 kWh comprises a switchgear element, a switched-mode power supply (SMPS) and 17 battery modules. Each module contains eight series-connected 67 Ah, 3.8 V cells and a dedicated battery management system (BMS) with cell balancing functionality. The switchgear

collects all information about each battery cell, calculating the state of charge (SoC) and state of health (SoH). The SMPS supplies the power for the BMS and communicates with the UPS and other connected cabinets. Battery cabinets are compact, thus saving real estate and increasing power density, and may be connected in parallel to achieve the power needed.

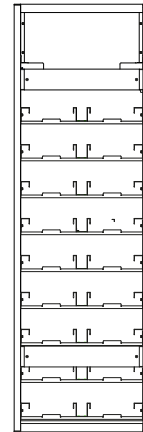

## UPS lithium-ion battery system

### Technical specification

General data	
Nominal energy (kWh)	34.6
Capacity (Ah)	67
Open circuit voltage (V)	516.8
Operating voltage (V)	435V / 571.2
Charging current (A)	22
Operating temperature (°C)	18–28
Maximum discharge current (A)	470A (60 sec) 600 (1 sec)
Product compatibility	
DPA 250 S4	Yes
DPA 500 IEC 400 V	Yes
MegaFlex DPA IEC 400 V	Yes
PowerLine DPA	Yes
PowerWave 33 S3	Yes
TLE Series IEC	Yes
Batteries	
Type	Li-Ion
Weight	
Weight with batteries	550 kg
Dimensions	
Dimensions w × h × d	650 x 2055 x 600 mm

# Connectivity solutions

## Smart power monitoring for single or multiple systems

ABB offers intelligent solutions that monitor the status of your power system and thus ensure your data storage equipment or control process continues to receive clean, reliable power. The monitoring devices provide real-time visibility of the condition of your power equipment and help in identify problematic trends before they become critical.

### Power and environmental monitoring

Network interface cards connect ABB's UPS systems to the network. These cards also provide the ability to connect several environmental sensors to the UPS. This combination allows for a clear visual representation on a web interface of not only the UPS system but also its environment.

### Management software

The network interface cards are provided with extensively configurable software that provide access to measurement values and to the UPS's status information. The status of each UPS cabinet, UPS module or the entire system can be presented on a separate mimic diagram. These diagrams provide users with clear, real-time information. During normal operation, records of all events are kept in a log file. In case of a power failure, battery autonomy is monitored and network shutdown of the protected devices is initiated.

### Data protection

The remote shutdown software manages a particular workstation, network or servers. Shutdown or reboot can be executed safely.

In addition, text messages, e-mails, pop-ups and mobile messages can be dispatched or displayed before the devices are shut down – giving the user the flexibility to manage or cancel the operation.



Connectivity components

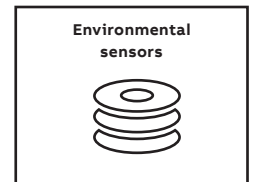
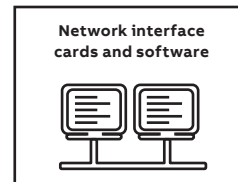

E-mails Several protocols

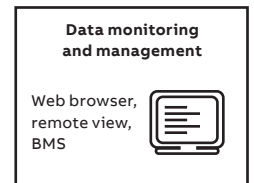
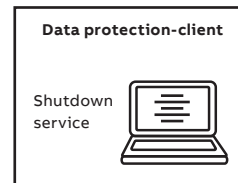

### Highlights

- Remote monitoring via web
- Environmental monitoring
- Extensive alarm handling and dispatching
- Redundant UPS monitoring
- Integration into network or building management system
- Integration into multivendor and multiplatform environments
- ModBus interface
- Multiple standard protocols are supported

### Applications

- Personal computers
- Servers and network devices
- Data centers
- Storage systems
- Industrial automation
- Power systems



# Connectivity solutions

## Network interface cards

ABB offers several network interface options to suit all the customers' needs:

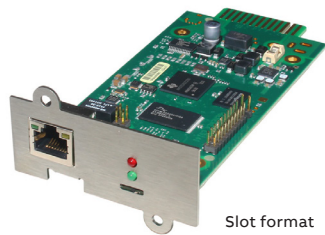

Slot format

### CS141 Basic

For interfacing the UPS with the network without the need for additional sensors or interfaces. Available in slot and box formats.

#### Supports the following protocols

1 HTTP	4 ModBus TCP
2 SNMP	5 Telnet FPT
3 SMTP (e-mail)	

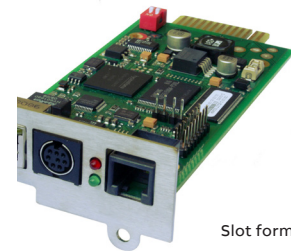

Slot format

### CS141 Advanced

For interfacing UPS with the network and allowing users to connect additional sensors and I/O options either directly to the card or via sensor manager. Available in slot and box formats.

#### Supports the following protocols

1 HTTP	4 ModBus TCP
2 SNMP	5 Telnet FPT
3 SMTP (e-mail)	6 ModBus RS-232



Box format

### CS141 ModBus

For interfacing UPS with the network and the ModBus RS-485 with option to connect alarms buzzers or additional relay board. Available in slot and box formats.

#### Supports the following protocols

1 HTTP	4 ModBus TCP
2 SNMP	5 Telnet FPT
3 SMTP (e-mail)	6 ModBus RS-485



Slot format

### USHA+

For interfacing UPS with the network with an option to connect additional environmental sensors. Available in slot format only.

#### Supports the following protocols

1 HTTP	4 ModBus TCP
2 SNMP	5 Telnet FPT
3 SMTP (e-mail)	

Slot cards are UPS powered, while cards in box format require external power.

# Connectivity solutions

## Monitoring for single or multiple systems

List of connectivity and sensor options for different network interfaces

CS141	Network interface*	CS141	Web / SNMP interface	ModBus TCP	Sensor connections	
					Options	Cable length
Network interface*	Box	CS141	Web / SNMP interface	ModBus TCP	No sensor options	
	Slot	Basic			No aux options	
	Box	CS141			Optional sensors	}
	Slot	Advanced			Aux connection	
	Box	CS141			ModBus RS-845	
	Slot	ModBus			Aux connection	
I/O options	Alarm buzzer CS141		Buzzer, 60 dB	5 m cable		
	Relay board CS141		4 digital inputs 4 relay outputs	1 m cable		
	Profibus converter		External DIN rail mount device			
	Temperature sensor		-25°C to +100°C, ±0.5%	1.8 m cable		
	Combisensor for temperature and humidity		-25°C to +100°C, ±0.5% 0% to 100% RH, ±5%	1.8 m cable		
Sensor manager options	Sensor manager		Environmental interface			
	Temperature sensor		0°C to +100°C, ±0.5%	5 m cable		
	Combisensor for temperature and humidity		0°C to +100°C, ±0.5% 0% to 100% RH, ±5%	5 m cable		
	Alarm buzzer		85 dB	5 m cable		
RCCMD	Relay box		1 input contact 1 output contact	5 m cable		
	RCCMD license		For Windows, Linux, MAC X, OS / 2, UNIX, NOVELL			
	RCCMD license		For IBM AS 400 V4R5, V5, V6, V7			
	RCCMD enterprise license		>50 licenses (Windows, Linux, MAC X, OS / 2, UNIX, NOVELL)			

USHA+	Network interface**	USHA+	Web / SNMP interface	ModBus TCP	Sensor connections		
					Options	Cable length	
Environmental	USHA+ network interface card		Web / SNMP interface	ModBus TCP			
	EMD with temperature and humidity sensors				0°C to +80°C, ±1°C 10% to 90% RH, ±3%	2 m cable	}
	Vibration detector					1 m cable	
	Smoke detector						
	Door contact detector						
	Water leakage detector						
Water leakage detector							

\* All CS141 cards / boxes come with one free RCCMD client and a CD containing the monitoring software.

\*\* All USHA+ cards come with RCCMD client and a CD containing the monitoring software.

## Connectivity and sensor options for CS cards and boxes

### Basic

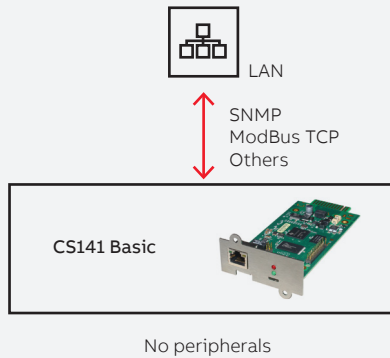

### ModBus

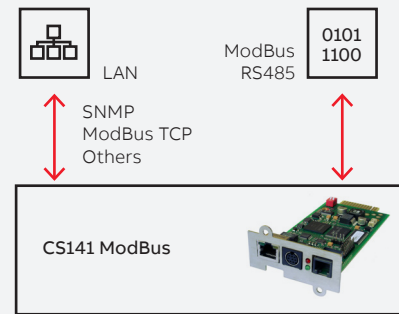

### Advanced

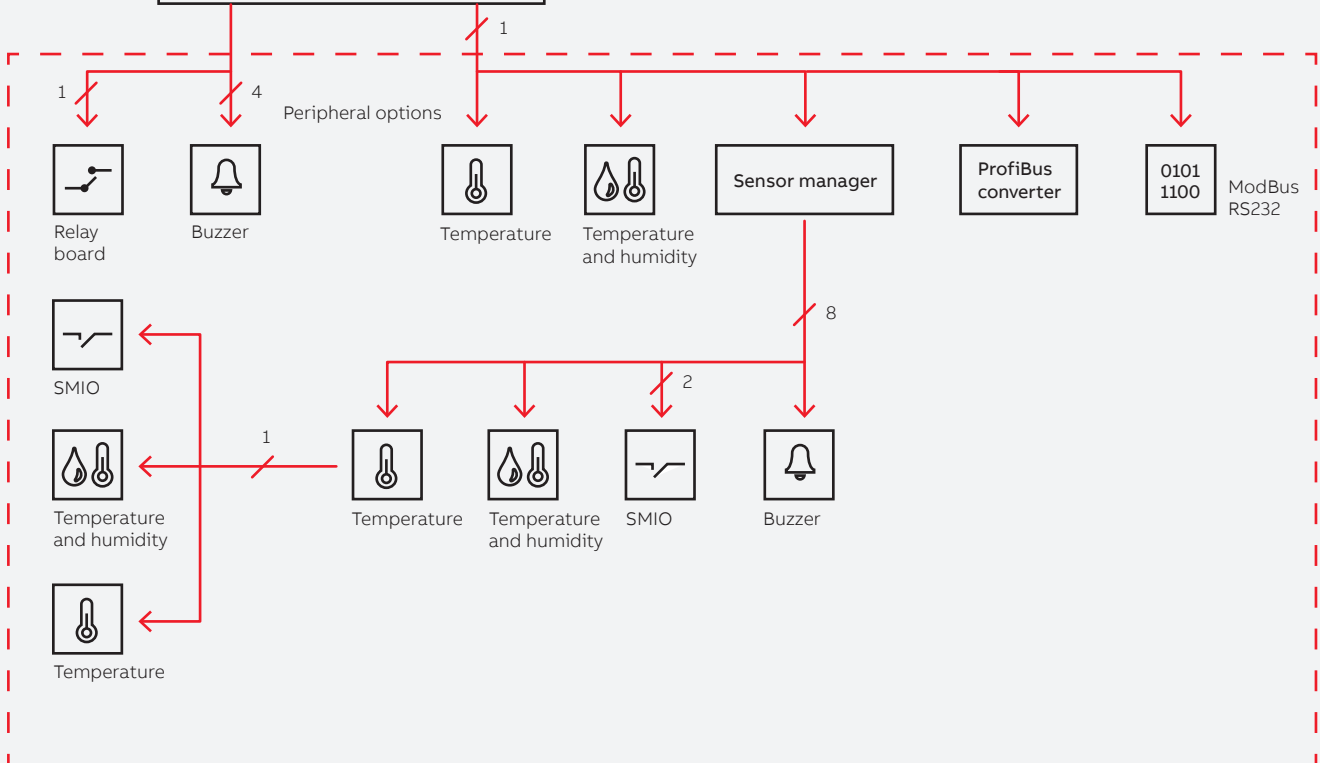
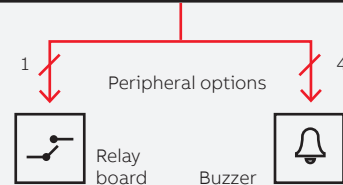
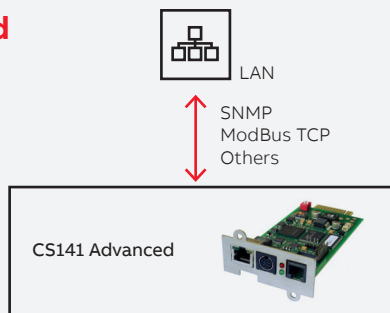

## Connectivity and sensor options for USHA+ card

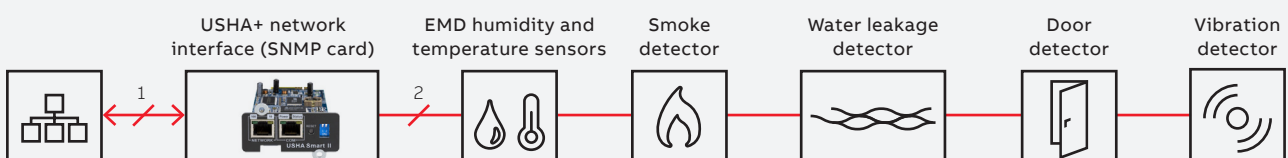

—  
**ABB Power Protection SA**  
Via Luserte Sud  
6572 Quartino  
Switzerland

[abb.com/ups](http://abb.com/ups)

