

ABB-free@home[®] System Manual

Content

01	System requirements	4
02	Performance Features	5
03	Planning and Installation	6
04	Commissioning	14
05	Types of Devices	34
06	Device Functions	60
07	Overview of Product Range	62
08	FAQ und Tipps	72

01 System requirements

User interface

To open the web-based user interface of the System Access Point you require a computer with a LAN or WLAN network adaptor and an installed Internet browser.

The recommended browsers are:

- » Firefox (from version 9)
- » Internet Explorer (from version 11)
- » Google Chrome
- » Safari

free@home app

For the installation of the free@home app you require a smartphone or tablet with an Android (from 4.4) or iOS (from iOS 7) operating system.

Home network

To be able to access the free@home APP and Internet services (e.g. e-mail) at the same time during standard operation, the System Access Point must be integrated into the existing home network after commissioning. For this, a router with Ethernet or WLAN interface is required.

02 Performance Features

The free@home system is a twisted-pair-based bus system for home automation. It enables the control and automation of lighting, heating, and blinds and also provides integration of the ABB-Welcome door communication system.

Control takes place on site using permanently installed control elements or mobile using a smartphone or tablet.

Functions are allocated only by software; i.e., if the use of a room changes in future, the function of the light switch can be easily changed, as well.

No special software is required for commissioning. Configuration takes place using the available Internet browser of the computer, or the free free@home app for smartphones or tablets (Android/iOS).

A free@home system is made up of the following devices:

- » a System Access Point,
- » a power supply,
- » sensors for local operation,
- » actuators for switching loads.

Performance features

Up to 64 devices can be installed in a system (power supply is not included).

The following versions of devices are available:

System devices

- » System Access Point
- » Power supply

Sensors

- » Control elements
- » Panels
- » Binary inputs
- » Room temperature controller
- » Movement detector

Actuators

- » Switch actuators
- » Dimming actuators
- » Blind actuators
- » Heating actuators

Sensors and actuators are each available in construction types **flush-mounted**, **flush mounted pill** and **rail-mounting (MDRC)** and can be combined as required according to application.

The web-based user interface of the System Access Point can be called up and operated simultaneously by several participants (computers and/or mobile devices with the free@home app). This can, depending on the changes made, lead to losses in performance (the changes take longer to implement). That is why it is recommended to operate the user interface with only 4 participants at the same time.

03 Planning and Installation

System Access Point and power supply (Fig. 1)

The System Access Point offers the opportunity for accessing the free@home system with the PC or mobile terminal devices. This allows the functions of the system to be programmed and remote controlled.

Each system requires a power supply. It uses the voltage required by the bus subscribers for supplying the bus communication part of the devices.

Decentralized or central installation of the actuators (Fig. 2)

The free@home system offers both rail-mounting actuators for central installation in the switch cabinet as well as sensor/actuator units for decentralized flush-mounted installation.

Both types of installation can be mixed within the system as desired.

Advantages of the decentralized installation

- » "All-in-one": Sensor and actuator are located in the one device.
- » Function does not need programming since sensor and actuator have been pre-configured.
- » Usual manner of wiring of the 230 V line.

Advantages of the central installation

- » Inexpensive channel price due to multiple actuators.
- » Easy installation of the sensor technology since only the bus line is installed in the flush-mounted box.

Fig. 1 Plan of system

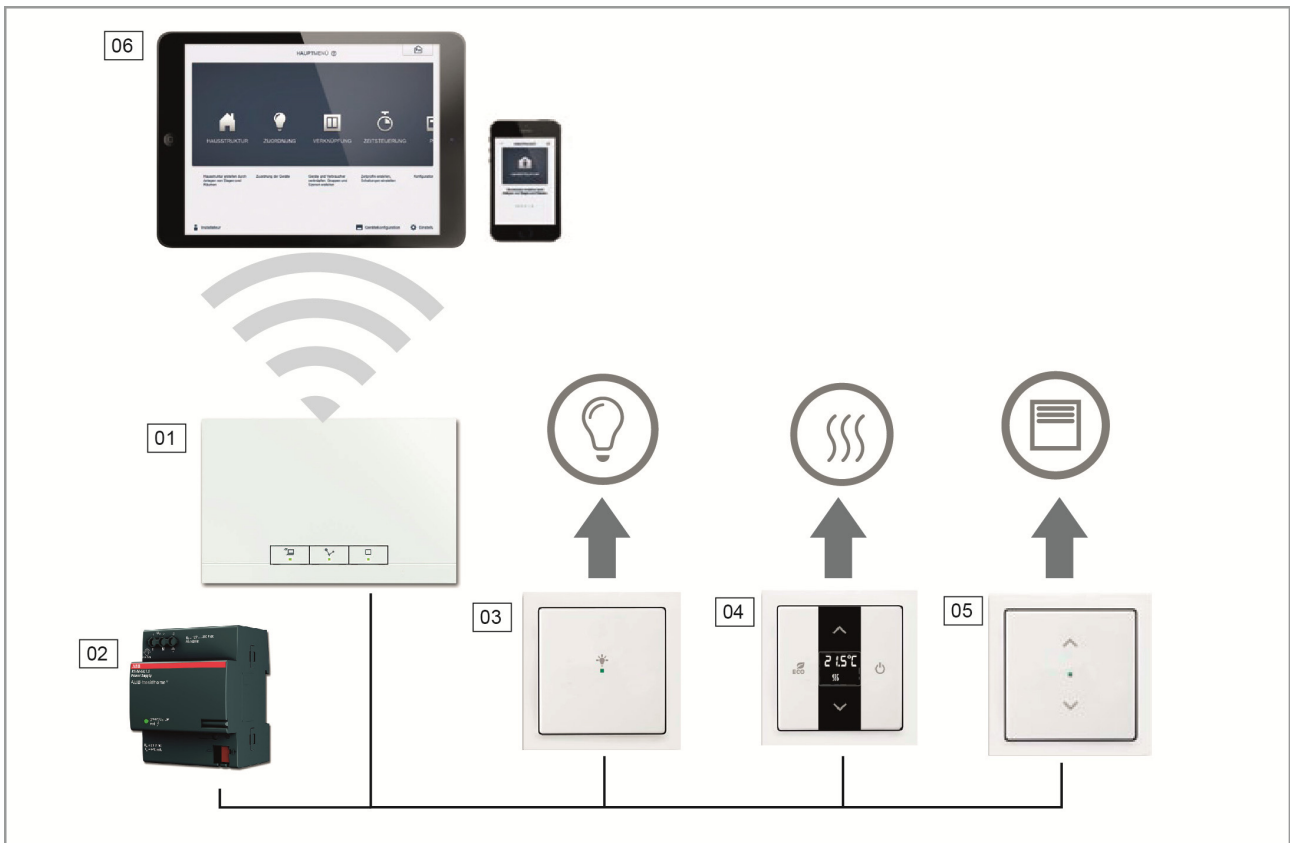

01 - System Access Point
02 - Power supply

03 - Sensor/switching actuator unit
04 - Room temperature controller

05 - Sensor/blind actuator unit
06 - Mobile terminal devices

Fig. 2 Planning of the actuators

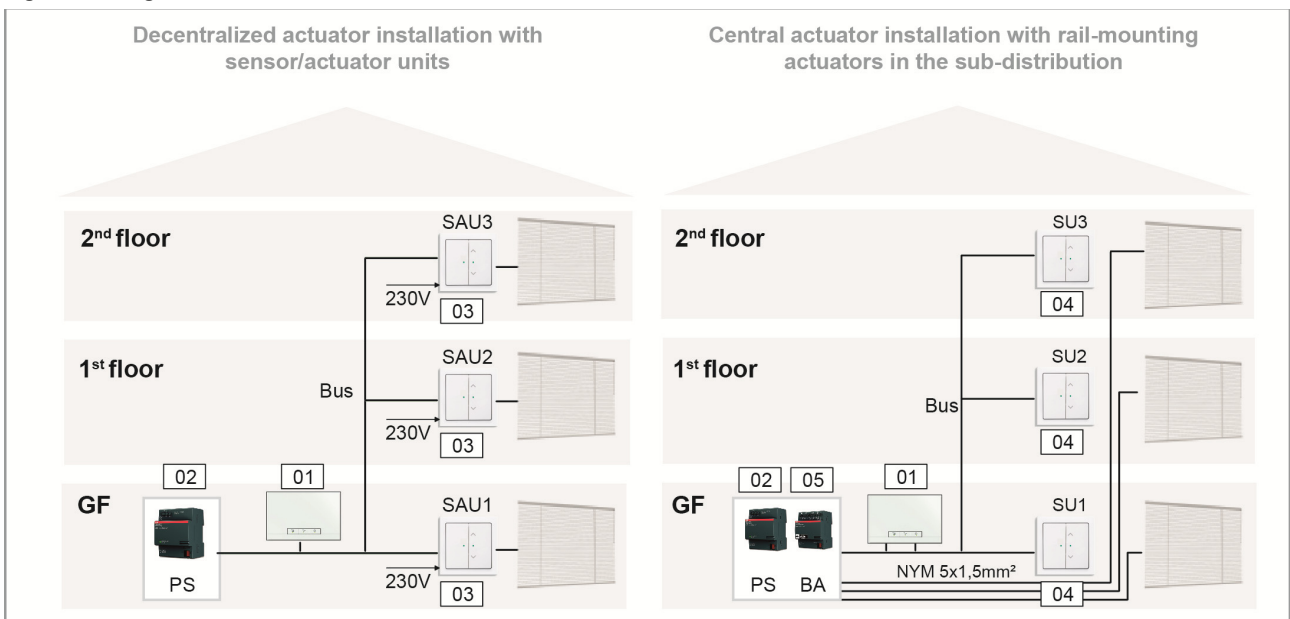

01 - System Access Point
02 - Power supply (PS)

03 - Sensor/blind actuator unit (SAU)
04 - Sensor unit (SU)

05 - Blind actuator (BA)

Topology of line participants

The free@home system communicates via the data bus. This means that each participant must be connected to the bus to be able to communicate with other participants.

Participants

Each free@home device, with the exception of the power supply, counts as participant. Up to 64 participants can be connected to the bus.

Note:

The System Access Point also counts as a participant.

Line topology (Fig. 3)

The free@home bus line can be installed in almost any manner desired.

- » Mixing the line topologies of linear, star and tree is permitted.
- » Only rings must not be set up.
- » No terminal resistors are required.

Lengths and distances of lines (Fig. 4)

- » **A** - Max. lengths of lines: The lengths of lines within a line are limited to a total length of **max. 1,000 m**.
- » **B** - The maximum distance between power supply and the last participant: **max. 350 m**.
- » **C** - The maximum distance between two participants: **max. 700 m**.

BUS line

The bus line leads to the participants.

- » A KNX-certified bus line (J-Y(ST)Y 2x2x0.8) is to be used.
- » Aside from the necessary physical characteristics (number of wires, cross-section, insulating voltage, etc.) the bus line can be differentiated immediately from other low-current lines.

Fig. 3 Possible topologies

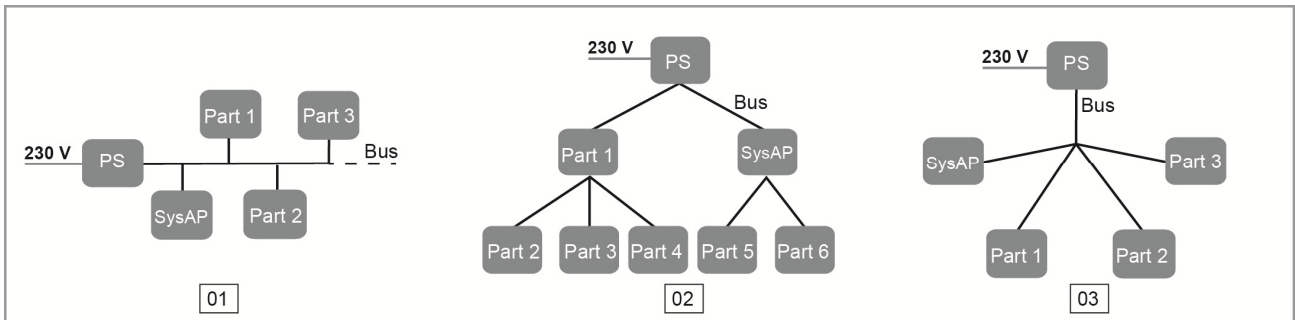

01 - Linear topology
 02 - Tree topology
 03 - Star topology

PS - Power supply
 Part 1 - Participant 1
 SysAP - System Access Point

Fig. 4 Lengths and distances of lines

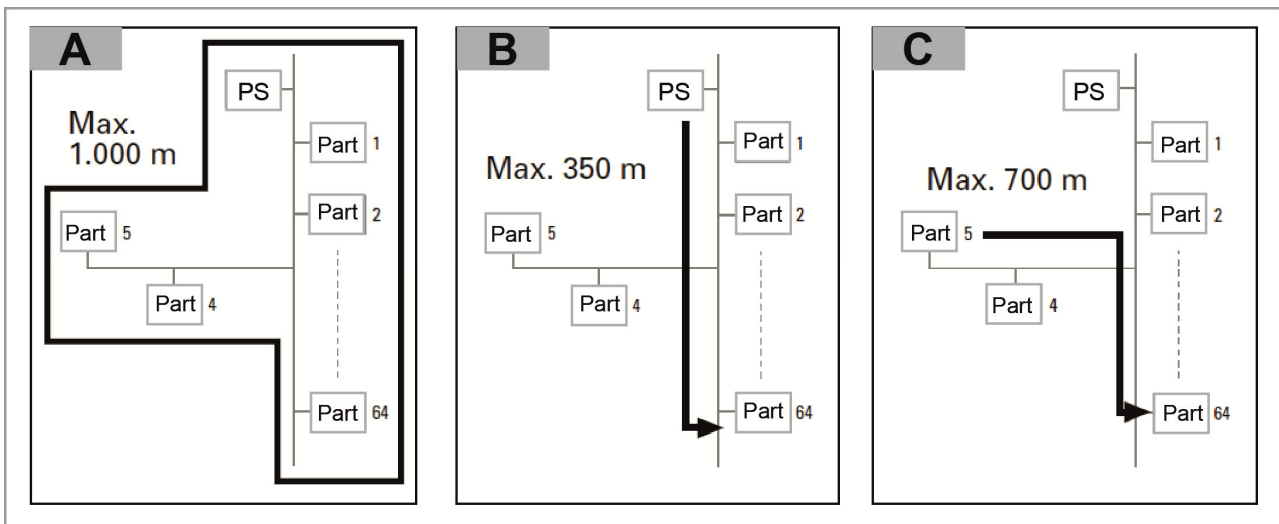

Planning of the System Access Point

The System Access Point makes available its own WLAN during commissioning, so that it can be comfortably programmed in mobile mode, even when no network infrastructure is available.

However, in the final state the System Access Point should be set up as participant within the available network infrastructure.

The System Access Point can be connected to the available network infrastructure of the apartment either via the installed Ethernet port or the installed WLAN antenna.

Connection via WLAN (Fig. 5)

If the System Access Point cannot be connected to the Internet router via cable, it can be logged into the existing WLAN network via WLAN as client.

Connection via patch cable (Fig. 6)

If the System Access Point and Internet router are installed side by side, they can be connected via a patch cable.

Connection via installation cable in case of structured cabling (Fig. 7)

If the System Access Point is to be connected via a CAT installation cable, it can be connected via the RJ45 socket with an LSA adapter.

Fig. 5 Connection via WLAN

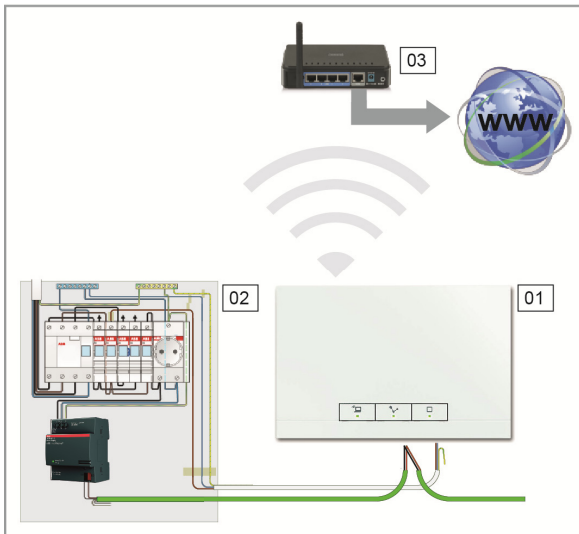

- 01 - System Access Point
- 02 - Distribution
- 03 - IP-router

Fig. 6 Connection via patch cable

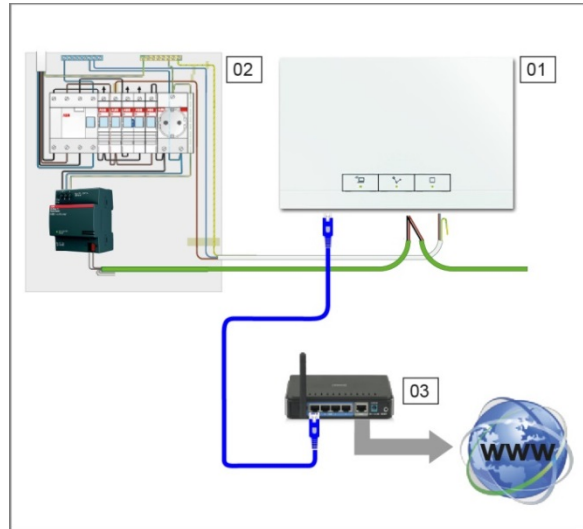

- 01 - System Access Point
- 02 - Distribution
- 03 - IP-router

Fig. 7 Connection via installation cable in case of structured cabling

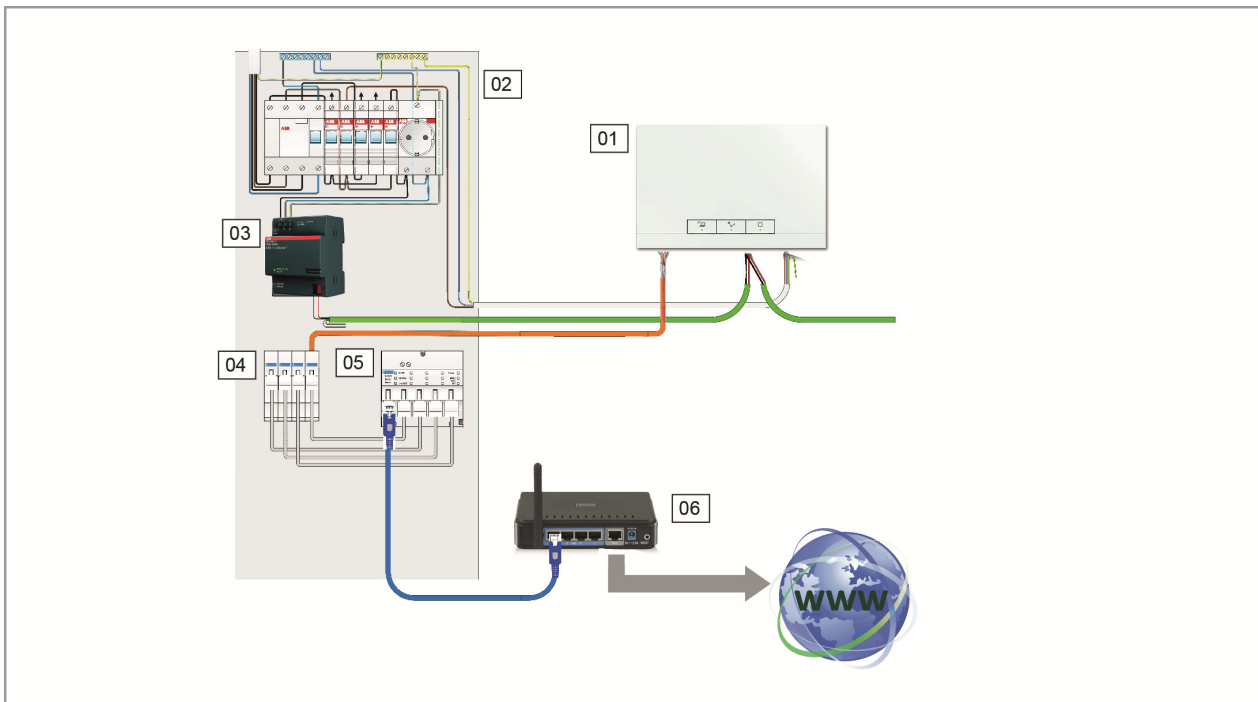

- 01 - System Access Point
- 02 - Distribution
- 03 - Power supply
- 04 - Ethernet patch terminals
- 05 - Switch
- 06 - IP-router

Creating a plan for devices (Fig. 8)

Each free@home device has a clear, eight-digit serial number. It is affixed permanently to each device as well as on a removable identification label.

It serves as an aid for identifying the devices during commissioning.

To facilitate the input a three-digit character code, which is generated from the specific serial number, is additionally available. Although it does not clearly identify the device, its accuracy, however, is sufficient to make it unique in the system.

To be able to identify the devices and channels more clearly during commissioning, it is recommended to document the three-digit character code of the devices, their function and location already during their installation.

- » To do this, pull off the removable labels from the devices and document the associated functions on the enclosed master (Plan of devices; see Fig. 48).

Fig. 8 Plan of devices

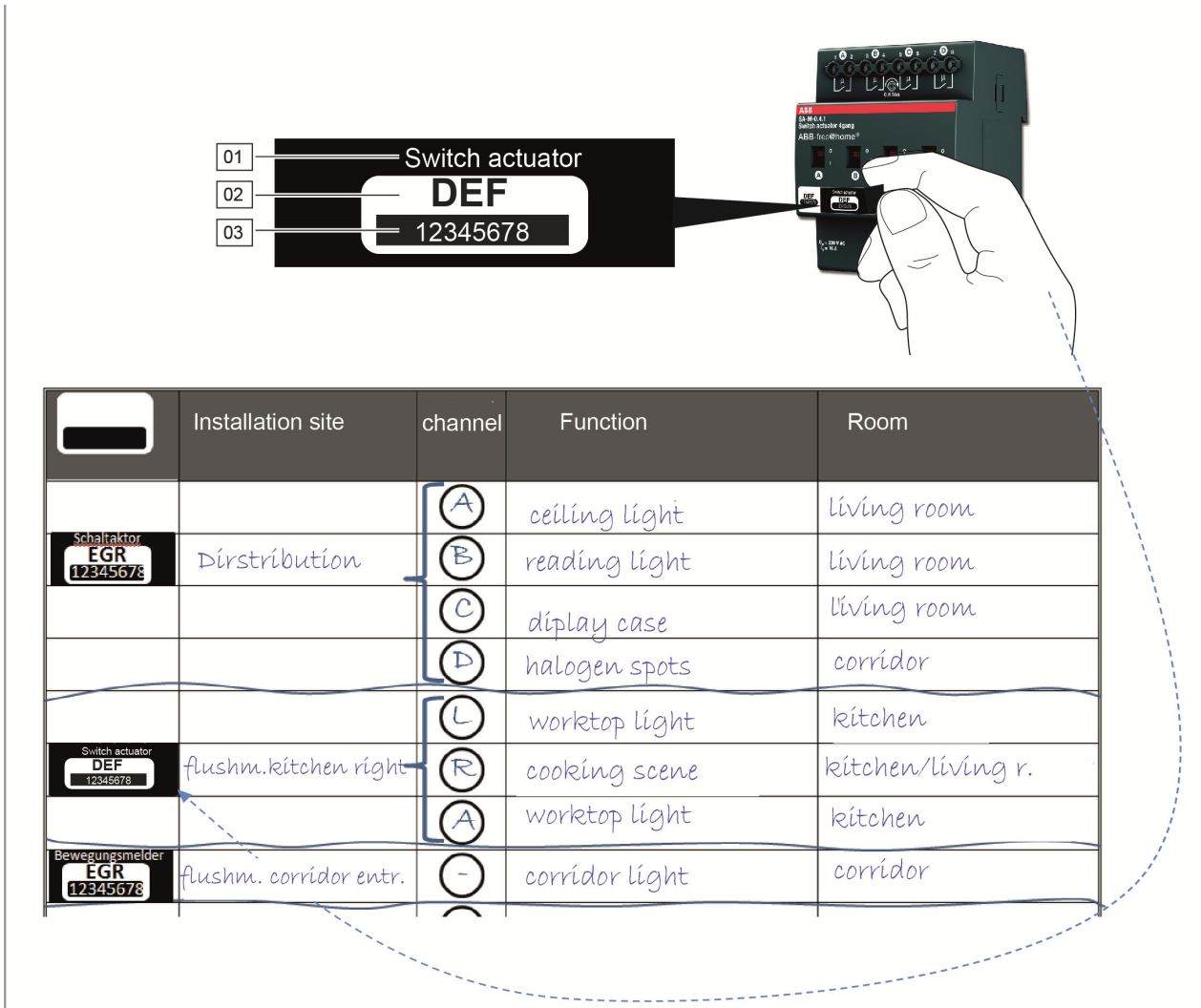

01 - Distribution
 02 - Identification number
 03 - Serial number

04 Commissioning

Prerequisites

Commissioning is always carried out via the System Access Point.

- » A smartphone, tablet or PC is required for commissioning.
- » No additional software is required.

The use of the free@home app is recommended for commissioning via smartphone or tablet. It can be downloaded free of charge from the App Store (for iOS) or from the Google Play Store (for Android).

Establishing the connection to user interface of the System Access Point

Use one of the following options to open the user interface of the System Access Point:

Option A: Establishing the connection with smartphone / tablet (Fig. 10)

1. Install the free free@home app for Android or iOS.
2. Energize the System Access Point. Ensure that the access point mode has been activated (left button lights up). If not, press the access point button to activate it.
3. Connect the terminal device with the WLAN of the System Access Point (SSID: SysAPXXXX).
Enter the password (see text on the interior side of the power adapter in the System Access Point; open the cover for access).
4. Start the app.
5. The app establishes a connection to the System Access Point automatically.

Option B: Establishing the connection with the PC via WLAN (Fig. 11)

1. Energize the System Access Point. Ensure that the access point mode has been activated (left button lights up). If not, press the access point button to activate it.
2. Connect the PC with the WLAN of the System Access Point (SSID: SysAPXXXX).
Enter the password (see text on the interior side of the power adapter in the System Access Point; open the cover for access).
3. Start your Internet browser.
Enter the IP address "192.168.2.1" in the address line of your browser and confirm it.
4. The connection to the System Access Point has been established.

Fig. 9 Text on the interior side of the System Access Point

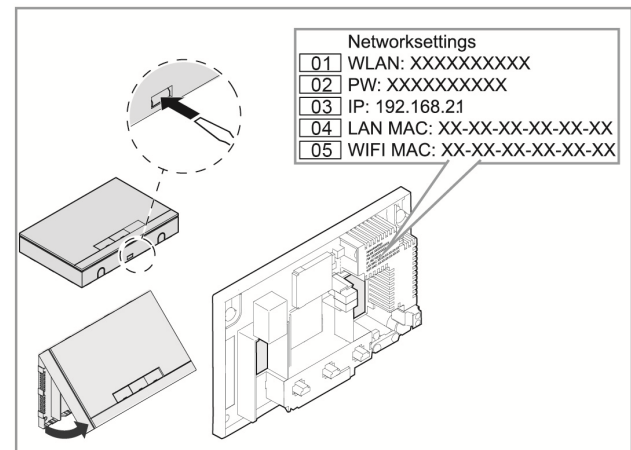

- 01 - WLAN password (SSID)
- 02 - Password
- 03 - IP address
- 04 - LAN MAC address
- 05 - WIFI MAC address

Fig. 10 Option A: Connection with smartphone



Fig. 11 Option B: Connection with PC via WLAN

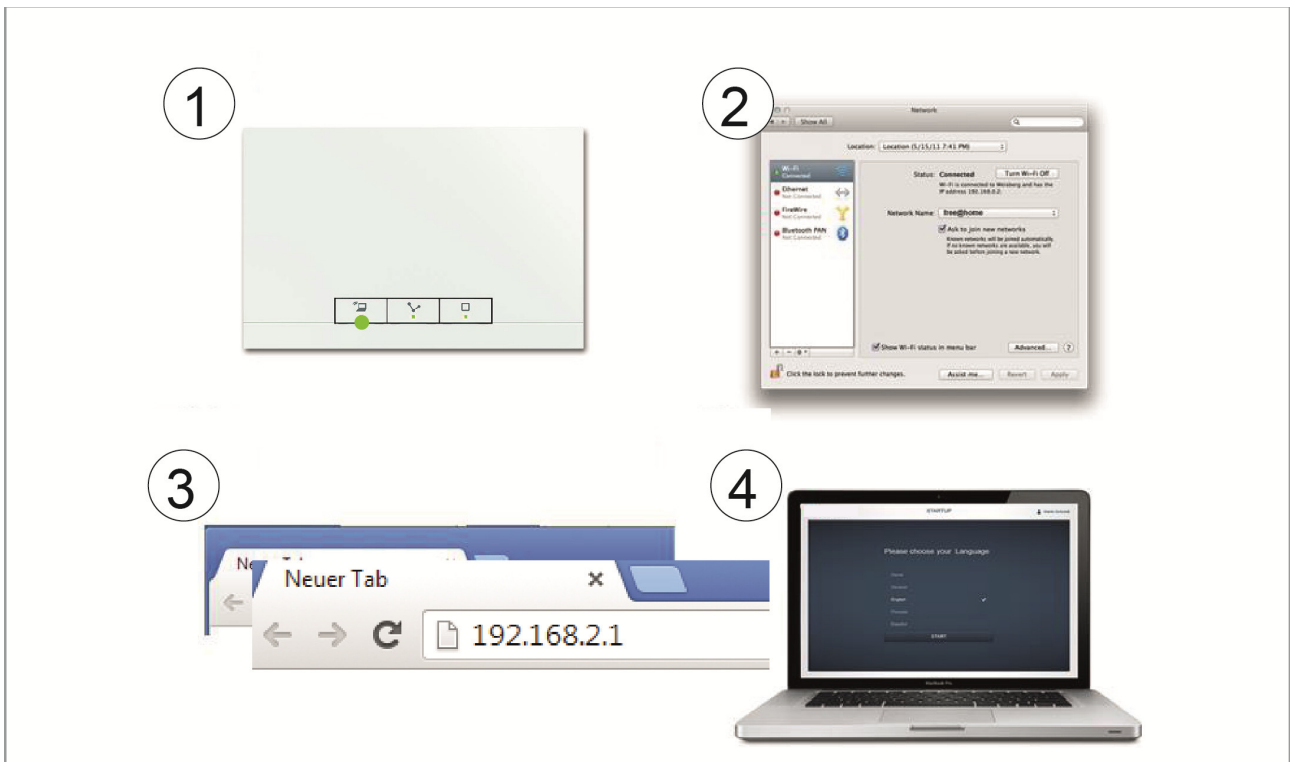

Option C: Establishing the connection with the PC via patch cable (Fig. 12)

1. Connect the System Access Point and the PC with the router.

Energize the System Access Point and ensure that the access point mode is not activated. If it is activated, press the access point button to deactivate it.

Note: The System Access Point now functions as "DHCP Client". This means that it can only be reached under the IP address that is assigned to it automatically by the router.

2. Call up the user interface of the System Access Point. There are 2 options:

A - Open the Windows Explorer on your PC. The System Access Point is displayed as device under "Network". Double click on the device to open the user interface (prerequisite: the computer must support UPnP).

B - Enter the IP address that has been assigned automatically by the browser in the address line of the browser (you will find the assigned IP address in the user interface of your browser).

Example, Fritzbox:

under "Home network->Network" set the view on "Extended" to fade in the IP address).

3. The connection to the System Access Point has been established.

Fig. 12 Connection via patch cable

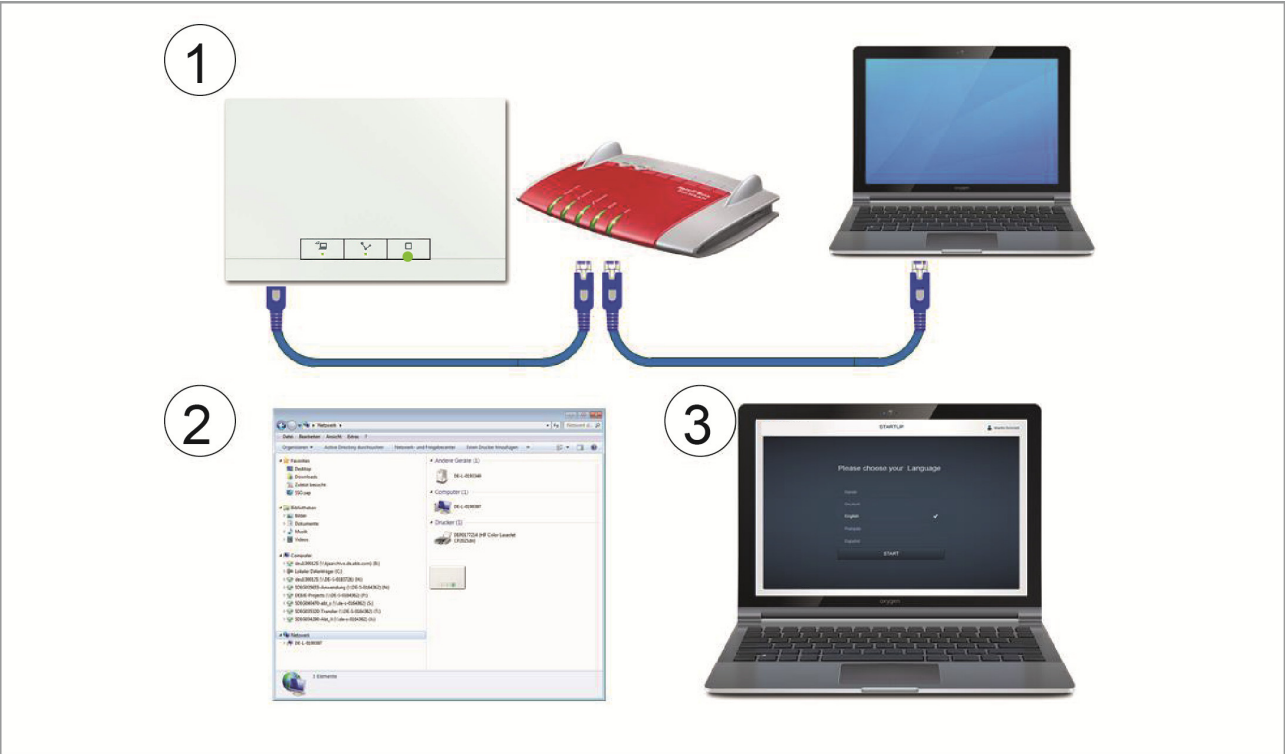

Note: The status-LED is described in detail in Fig. 46

Carrying out the basic settings of the user interface

Note: Detailed descriptions are available in each of the online Help of the individual pages under the button:



During initial commissioning, you will be asked to supply the following basic data:

Language (Fig. 13)

Selects the language of the display text. The following languages are available:

- » German
- » Danish
- » English
- » Spanish
- » Finnish
- » French
- » Italian
- » Norwegian
- » Dutch
- » Polish
- » Portuguese
- » Russian
- » Swedish
- » Chinese

Site

Basis for the astro function.

Date / Time

Sets the time for the system (Note: the time will be synchronized automatically when the connection to the Internet is established).

User name / Password

Ensures protection against faulty configuration (additional users can be added later).

Note:

The password must consist of at least 4 characters.

Name of installation

Display name of device within the IP network.

The data are saved on the System Access Point. The entry of the data can be skipped, which however, leads to the restriction of functions. However, the data can be also be entered at a later point in time.

Differentiating user rights

The system differentiates between 3 types of users with different access rights:

User 'Fitter'

- » Has all access rights (Master reset, creation of EF data protection).

User 'Configuration'

- » Cannot make changes critical to the system (changing settings related to the bundling of channels for dimmers, re-configuration of binary inputs).

User 'Operation'

- » Cannot make changes to the system, but only operate the devices.

Fig. 13 Basic settings



Setup of the main menu (Fig. 14)

The main menu is the starting base for all the steps to follow.

Located in the central area are the menu items that are to be processed step by step (from left to right) for the configuration.

Since the steps follow each other consecutively they remain deactivated until the preceding step has been executed.

Setup of the working area (Fig. 15)

The working area of menu items "House structure", "Allocation" and "Linking" is divided into two areas: the floor plan (working area) on the left side and the list view on the right side.

- » Each area can be enlarged or reduced via the title bar.
- » All actions can be carried out both in the floor plan and in the list view.
- » If a change is made in the floor plan, this change is also made in the list view and in reverse.
- » Both areas represent different views of the same configuration.
- » While the floor plan displays the graphical view and allows operation via drag-and-drop, the list view offers a clear tabular view.

Fig. 14 Setup of the main menu

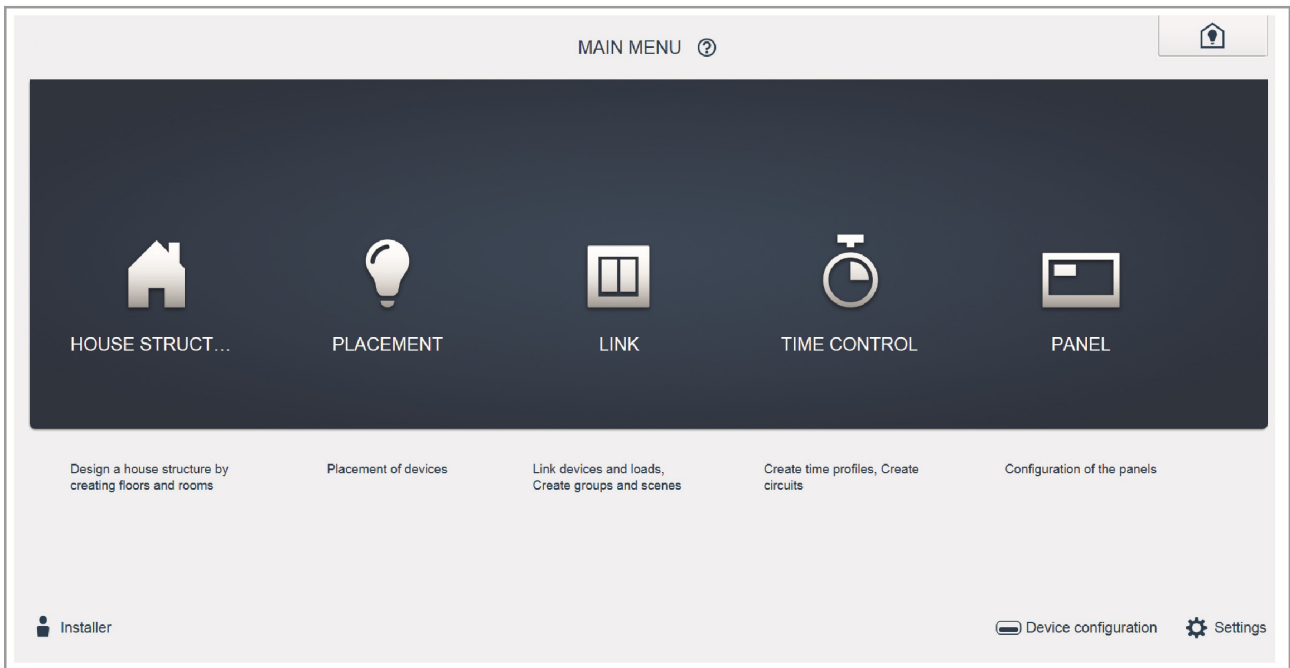
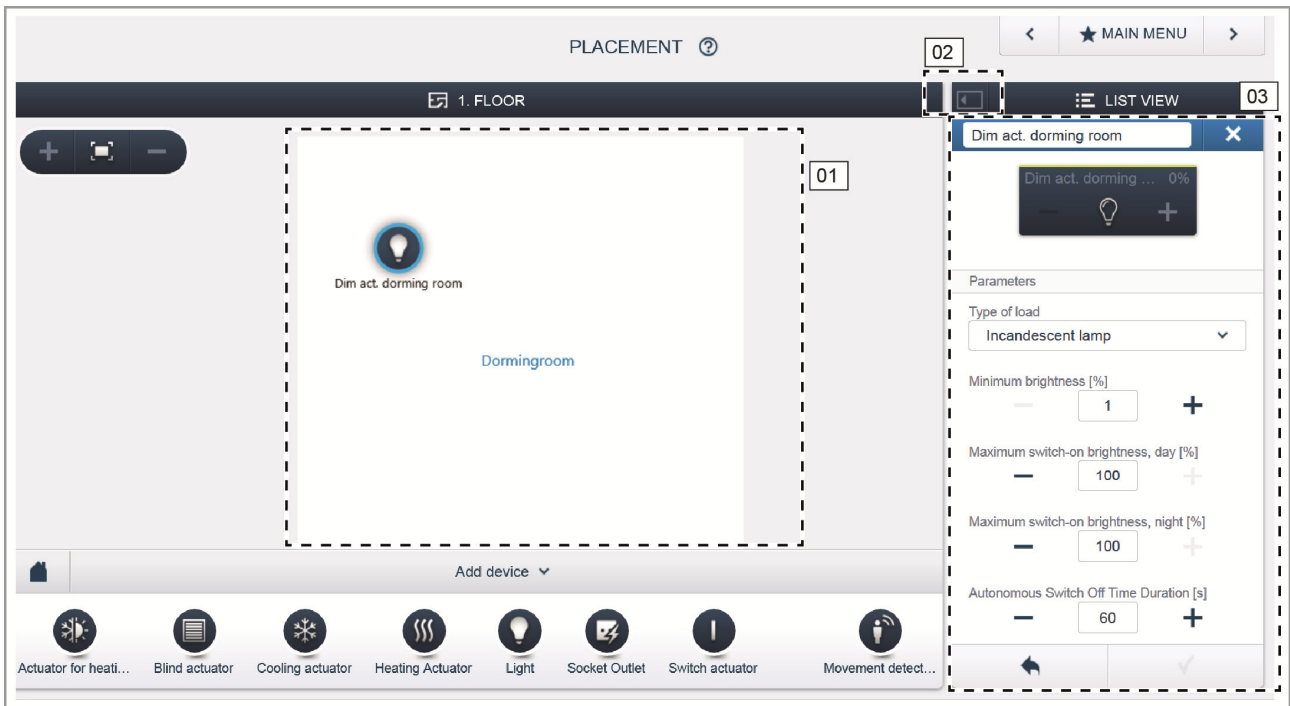

Fig. 15 Setup of the working area



- 01 - Floor plan
- 02 - Enlarge / Reduce
- 03 - List view

Creating the house structure (Fig. 16)

The first step of the configuration is the creation of the house structure.

Here a digital image of the apartment or the house with all its floors and rooms is created.

This information is used during the next step to allocate the devices available in the house to a function and to their mounting position.

After commissioning has been completed the floor plan here created is also used for the visualization of the installation and as orientation for the switchable loads.

If devices are also to be switched outdoors, e.g. lights on the terrace or in the garden, you should create a "Terrace" or "Garden" room, to be able to position the devices there.

Fig. 16 Creating the house structure - View of all floors

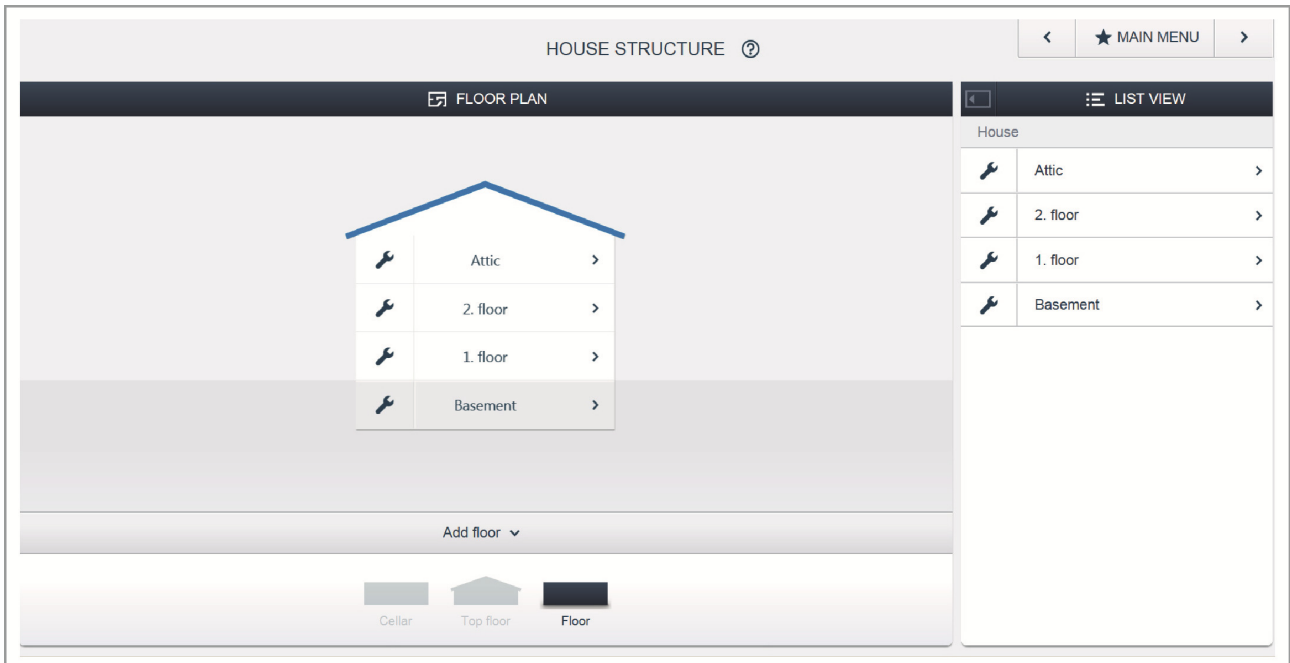
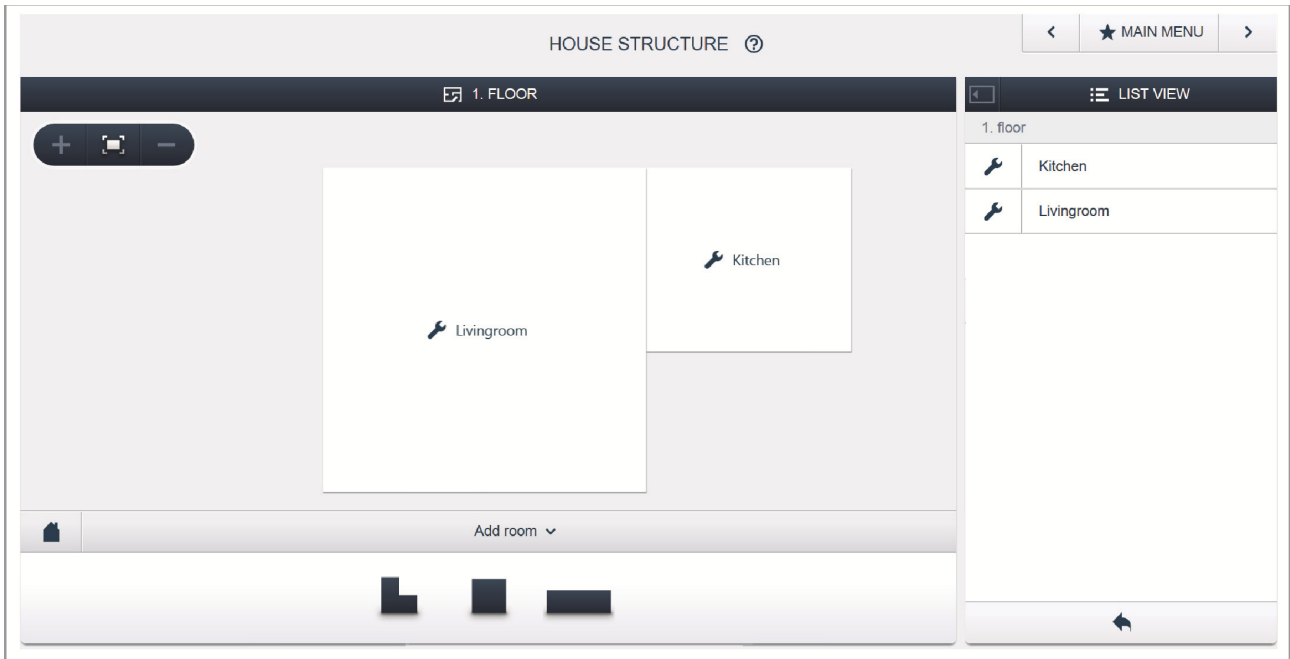

Fig. 17 Creating the house structure - View of one floor



Allocating devices to rooms (Fig. 18, Fig. 19)

During the next step the devices connected to the system must be identified, i.e. they are allocated to a room according to their function and are given a descriptive name.

In chapter 6 you will find a complete list of all applications that could appear here (depending on the devices that are actually connected to the system).

The "Add device" bar displays only those devices / functions that are actually connected to the system, and only until the devices have been moved on the floor plan via drag-and-drop. This means that the list keeps getting shorter as the devices are being positioned.

- » In the "Add devices" bar select the desired application and pull it via drag-and-drop into the floor plan (Fig. 18).
- » A pop-up window opens automatically which lists all the devices that are connected to the bus and suitable for the selected application (e.g. all blind actuators, if the blind application has been selected (Fig. 19).

Fig. 18 Dragging the application from the add bar

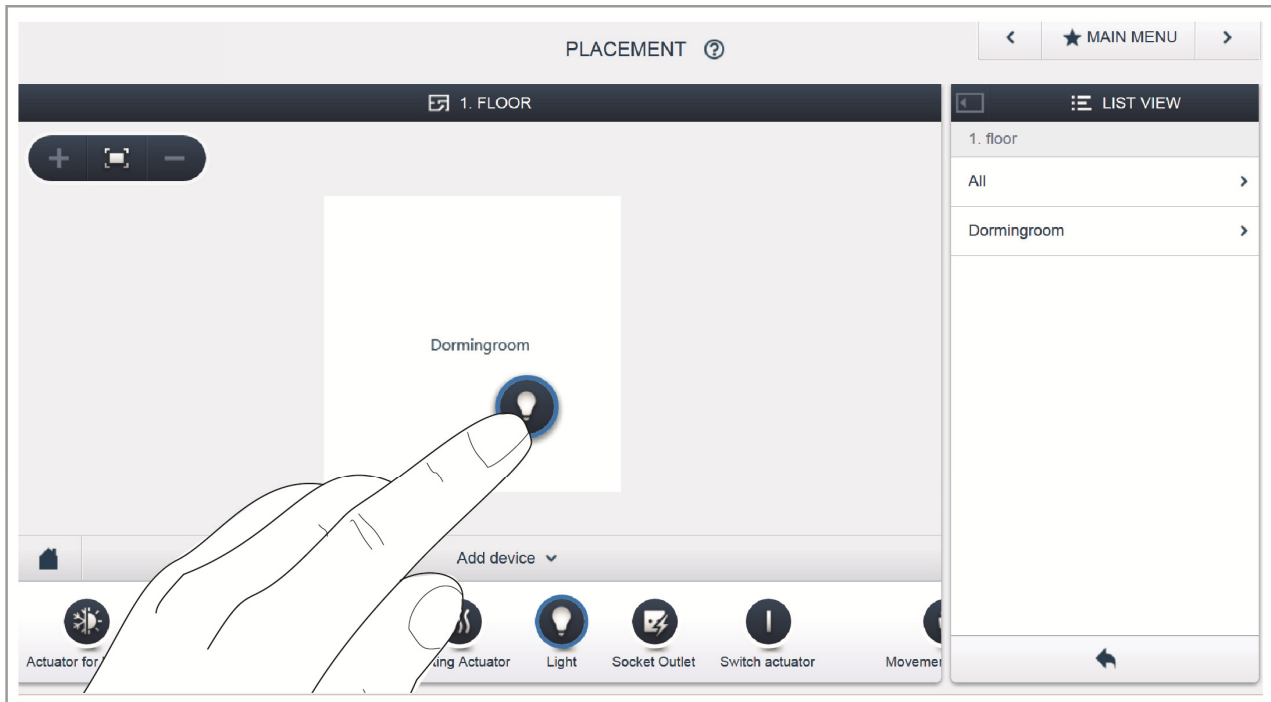



Fig. 19 Pop-up window with the suitable devices

ALLOCATION LIGHT	
Sensor/Dim actuator 2/1gang	 <p>Please assign a channel.</p> <p>Finding the correct channel depends on the device that has been identified.</p> <p>For most sensors, the sensor can be either switched directly or triggered. In the case of actuators, an element can be selected from the list on the left side. Here, the control button can then be used, for example, to identify a connected lamp.</p>
ABB700000003 EVU	
ABB700000021 KMM	
Sensor/Dimmaktor 2/1-fach	
ABB700000004 BXF	
Sensor/ Switch actuator 1/1gang	
ABB700000006 SFH	

Identification

If, after positioning on the floor plan, there are several possible devices in the pop-up window for selection, the device which switches the desired function must now be selected.

Identification via serial number (Fig. 20)

- » Compare the short 3-digit number (identification number) of the identification label on your device plan, or on the device, with the numbers in the list and in this way identify the device you are searching for and, if necessary, also the channel.

Identification via local operation (Fig. 21)

Go to the device that is to be linked with the selected application. Actuate the device:

- » Actuator: Press the "Ident" button on the device.
- » Sensor: Press the rocker.
- » Movement detector: Cover the lens with the hand.
- » The associated device is selected automatically. In case an actuator has several channels you now need to select the correct channel.

Identification via switching (only suitable for actuators, Fig. 22)

- » Select a device and a channel from the list.
- » Press the button in the detailed view of the device.
- » The connected load is switched.
- » Continue until you have found the device you are looking for.

Specifying a name (Fig. 23)

- » When the device has been found, enter a name that is easy to understand and under which the application is to be displayed later (e.g. "Ceiling light").
- » Press the tick at the bottom right to take over the entry.

Fig. 20 Identification via serial number

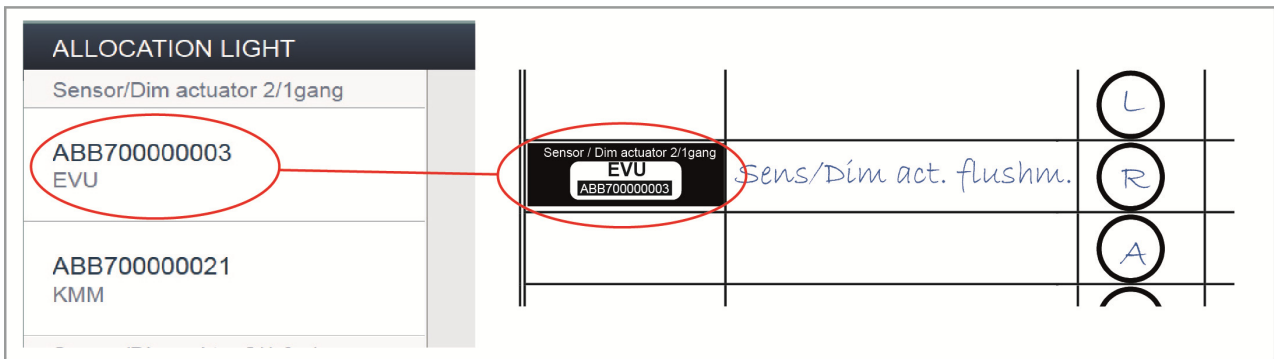

Fig. 21 Identification via local operation

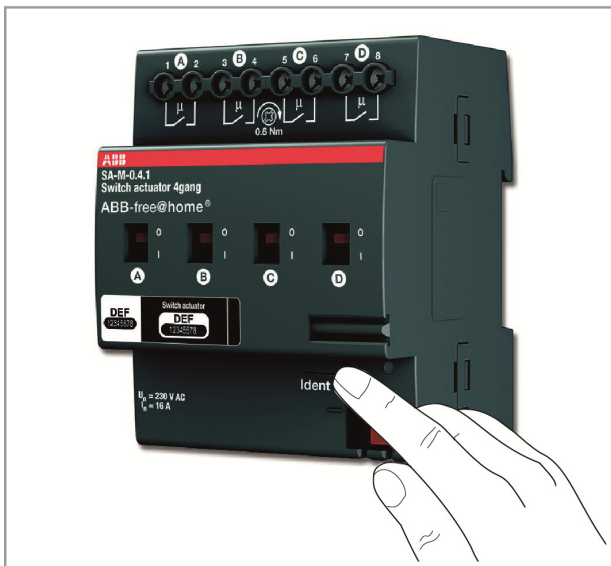

Fig. 22 Identification via switching

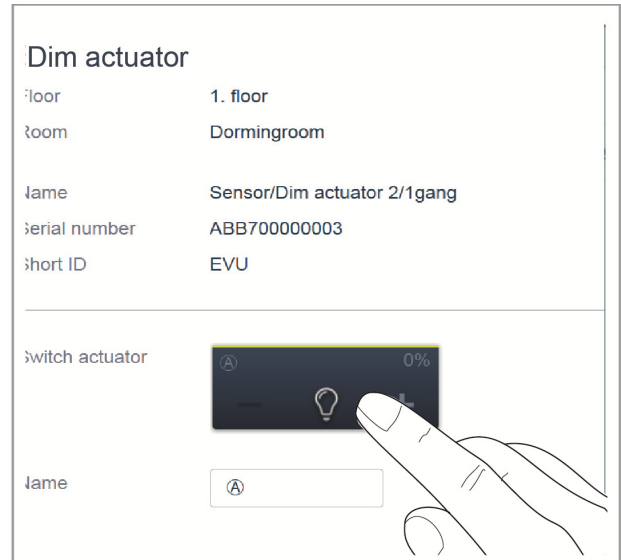

Fig. 23 Specifying a name



Linking sensors and actuators (Fig. 24)

The sensors and actuators created in step "Allocation" can now be linked to implement simple ON/OFF circuits, two-way circuits, scenes, and many more.

- » To connect an actuator with a sensor, first click on the desired sensor [1] which is to operate the actuator and then on the actuator [2].
- » Press the tick at the bottom right to take over the entry.
- » A blue connecting line indicates the link between the two devices. The configuration is now transmitted automatically to the devices. The transmission can (depending on the number of affected devices) take a number of seconds. During the transmission a progress bar is displayed around the devices affected.
- » After the transmission has been completed the sensor can be operated directly locally.

Switching options (Fig. 25)**Two-way circuit (01)**

An actuator is connected with one or several sensors.

Group circuit (02)

Several actuators of the same type (e.g. all the lights in a corridor, all roller blinds of a room) are combined in a group. The group acts like a single actuator and can be connected with sensors or integrated into scenes (at ON all actuators of the group switch on, at OFF they all switch off).

Scene (03)

A scene produces a state that can be defined by the user. This, for example, allows the user to create a "TV" scene that dims the living room light, switches off the lights in the corridor and dips the blinds. Scenes cannot be switched ON or OFF. The same pre-defined status is always restored when a scene is called up.

The states of the participants in a scene can be defined when the scene is created.

A created scene can also be linked with a sensor to enable it to be switched locally.

Fig. 24 „Allocation“ window

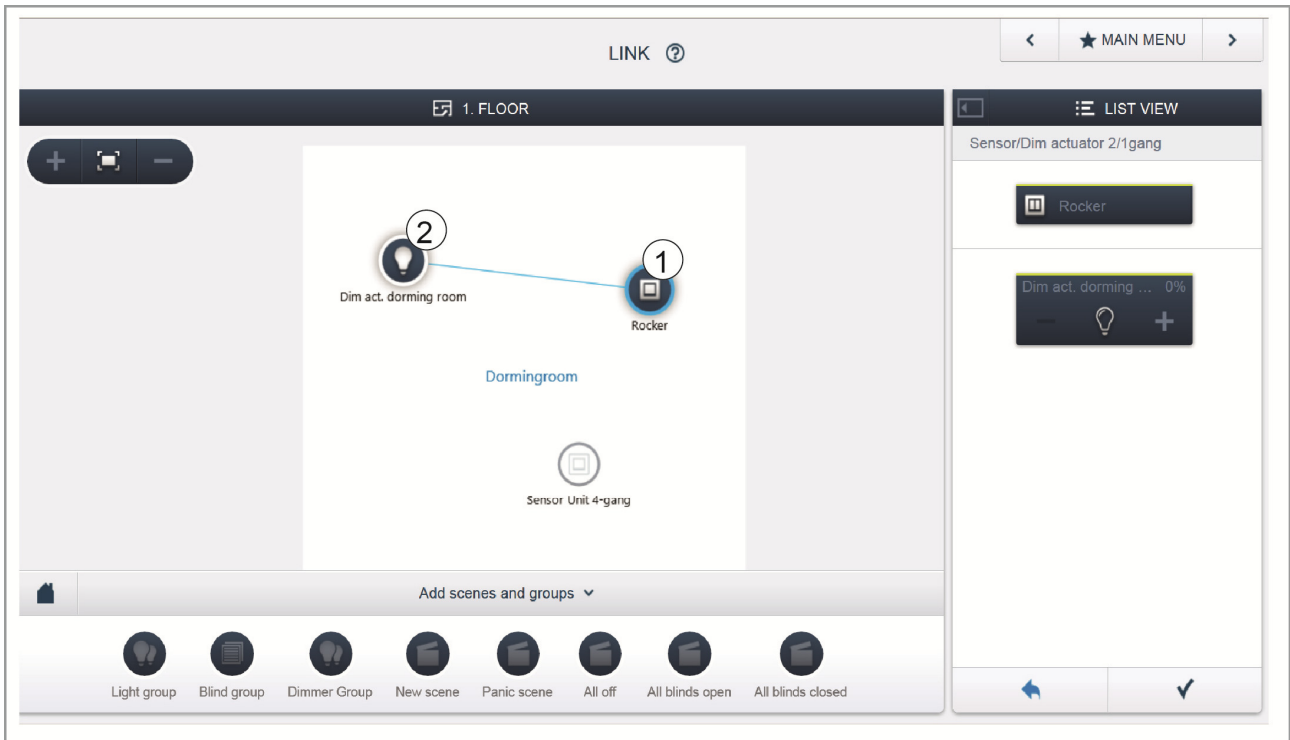
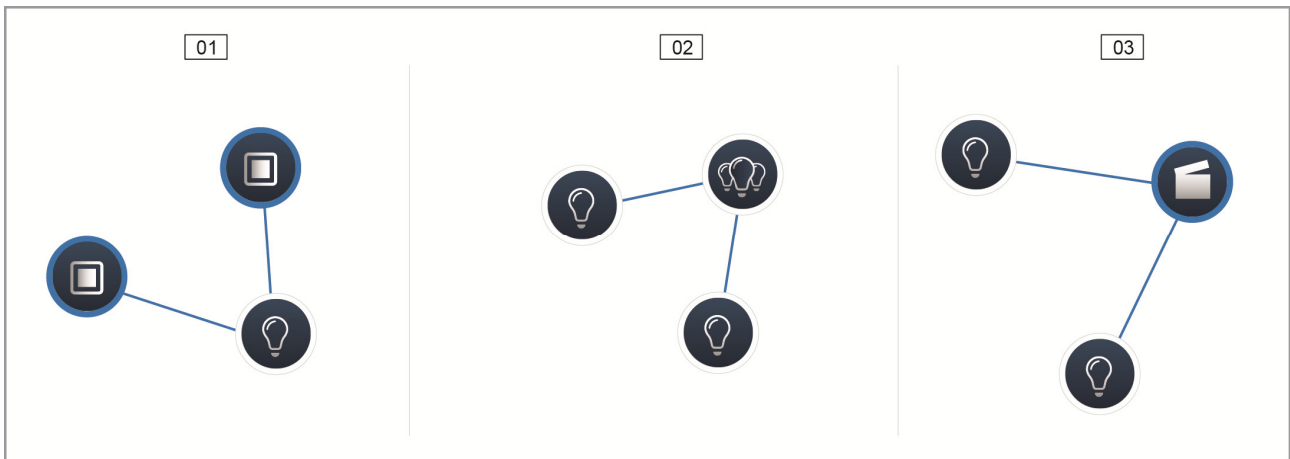

Fig. 25 Switching options



- 01 - Two-way circuit
- 02 - Group circuit
- 03 - Scene

Timer (Fig. 26, Fig. 27)

All programmed devices and scenes of the system can be switched automated via the timer (time profiles).

Time profiles

A time profile defines a collection of switching times. Several time profiles can be created and switched active / inactive independent of each other (green tick = time profile active -> saved switching actions are executed).

This, for example, allows separate time profiles for controlling blinds and lighting to be created, to obtain a better visual clarity. Or a special holiday profile can be created, which you only activate during your absence.

All time profiles are displayed in the profile view. When selecting a profile, all switching times for devices and scenes stored in this profile are indicated on a timeline in an overview display.

Additional profiles can be created and existing ones renamed or deleted via the spanner icon.

- » First select the profile you wish to edit and then click the spanner.

Contents from the profiles that have already been created can be taken over into the currently active profile via the arrow icon in the editing mode.

Two profiles have already been created in the factory settings:

- » Base profile,
- » Presence profile.

Base profile

The base profile can be freely edited. It already contains the object "Day/night switchover" in astro mode. The day/night switchover serves the control elements and the dimmers as switchover time between bright and dark for the status LED, and the switch-on brightness (settable in the parameters of the control element, and the dimmer).

Example of application: After 11 p.m. the corridor light is no longer to switch on with maximum brightness, but only with the reduced brightness of 40%.

Or: The light for orientation of the sensors in the bedroom is to be switched off after 11 p.m.

Presence profile

The presence profile is a special time profile with which presence simulation can be implemented.

The timeline of the presence simulation is filled with the desired switching actions, the same as a normal time profile. However, no switching time needs to be defined. Instead, the switching times are filled automatically with historical data of what actually took place.

It presents an image of customary use.

All the events of the last 7 days are stored in the historical data. What is not stored are events that were switched on and off in quick succession.

The presence simulation can be edited, activated and deactivated the same as all other time profiles. This means that additional switching events are added or certain events are deleted.

Timeline

The timeline displays all the switching times of a selected weekday. Switching actions that take place at the same time are displayed stacked.

The sun and moon icons indicate the time for sunrise or sundown.

The selection of a certain switching event changes the view to a detailed view (Fig. 27).

Here the switching time can be adjusted. Also the weekdays can be defined at which the event is to be repeated, or the circuit can be activated via the astro function.

Switching times can be linked with the times for sunrise and sunset via the astro function.

List view

All devices and scenes that have been programmed can be selected via the list view, sorted according to mounting position.

They can be positioned on the timeline via drag-and-drop to define the switching times.

Fig. 26 Time profiles

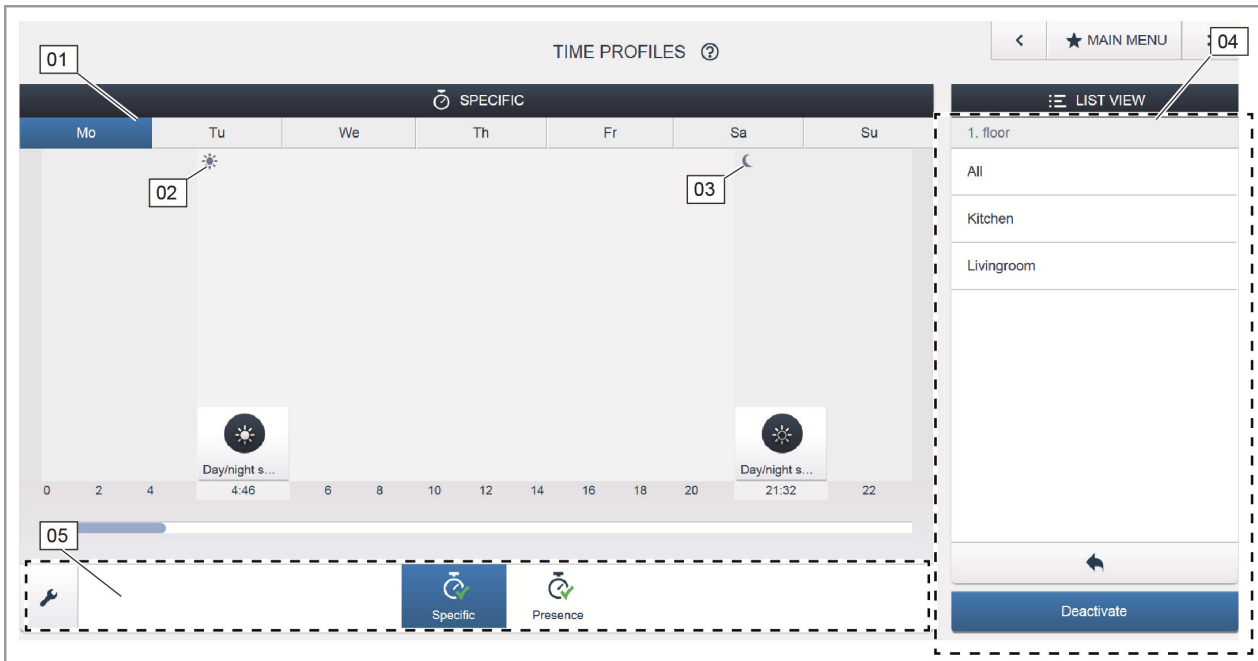

- 01 - Timeline
- 02 - Sunrise
- 03 - Sunset
- 04 - List view
- 05 - Overview of profiles

Fig. 27 Time setting

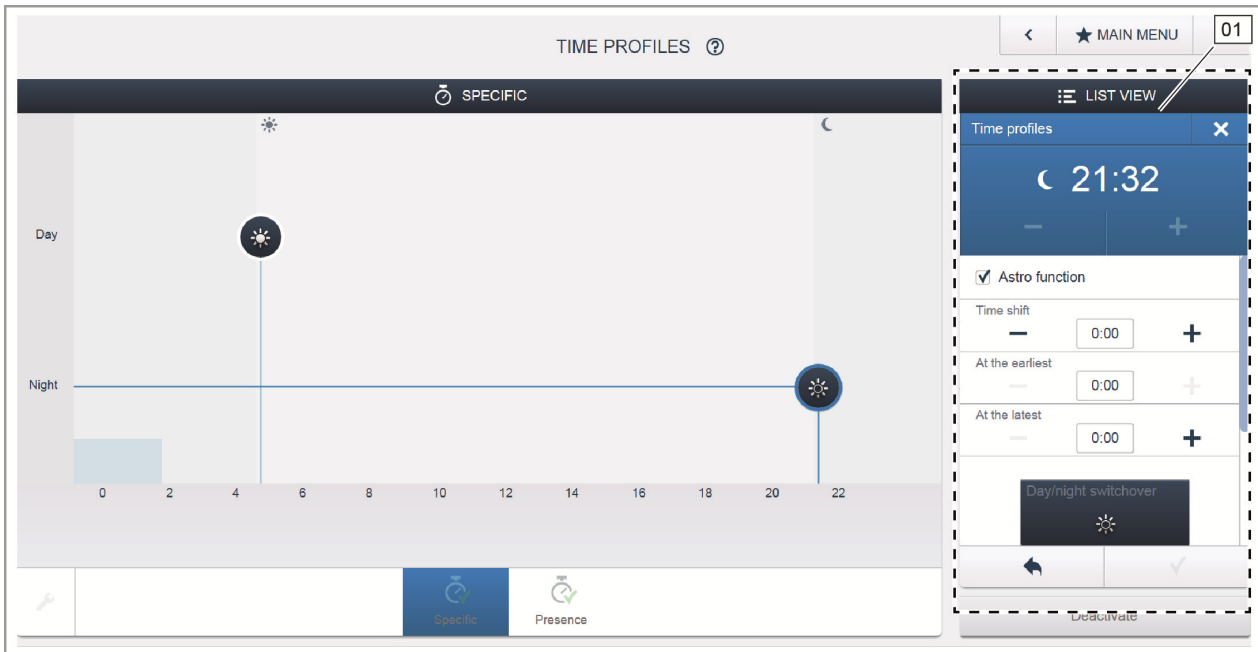

- 01 - Time setting

Panels (Fig. 28)

In the panel configuration the buttons of the free@home Touch 7" can be freely equipped.

All panels in the system and the favourites bar can be selected from the bottom selection bar.

Important: Only panels appear that have been previously positioned on the floor plan under commissioning step "Allocation"!

The allocated actuator channels can be positioned on the panel via drag-and-drop from the list view.

After the confirmation the configuration is taken over and becomes visible on the device after a few seconds.

Fig. 28 Panel



05 Types of Devices

Sensors and control elements

Control elements

Control elements can be used for the execution of different functions, e.g. switching lights, dimming lights, calling up scenes and moving blinds. They can be configured for controlling individual functions, for the execution of group functions or scenes.

A control element consists of a 1gang or 2gang sensor unit, or a sensor/actuator unit and one/two rocker(s).

Sensor unit

The sensor unit serves as a pure control element, i.e. manual switching commands of the user are recorded and sent to the bus. Remote actuators can be switched via the configuration. Loads can not be switched directly.

Sensor/actuator unit

Aside from their function as control element, sensor/actuator units also serve as switch for the switching of loads. The sensors and switching channels are pre-programmed when supplied, i.e. after activating the bus voltage and connecting the load, it can be switched directly on the control element.

Control element order items (Fig. 29)

The scope of delivery of the sensor unit, or the sensor/switch actuators, contains only the electronic insert. It must still be completed with a suitable rocker and a cover frame.

Rockers for control elements (Fig. 30)

The rockers of the control elements are available for the switch ranges solo, future, carat, Busch-axcent, and SI in the colours studio white, anthracite, aluminium silver, as well as white and alpine white. Depending on their use, the rockers can be selected with different printing.

Fig. 29 Control element order items

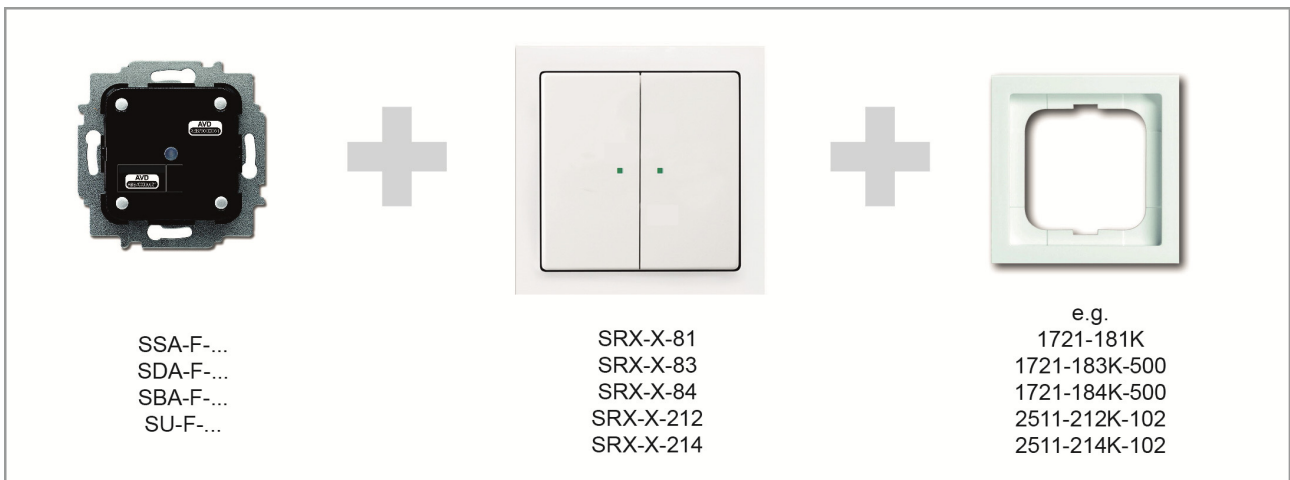
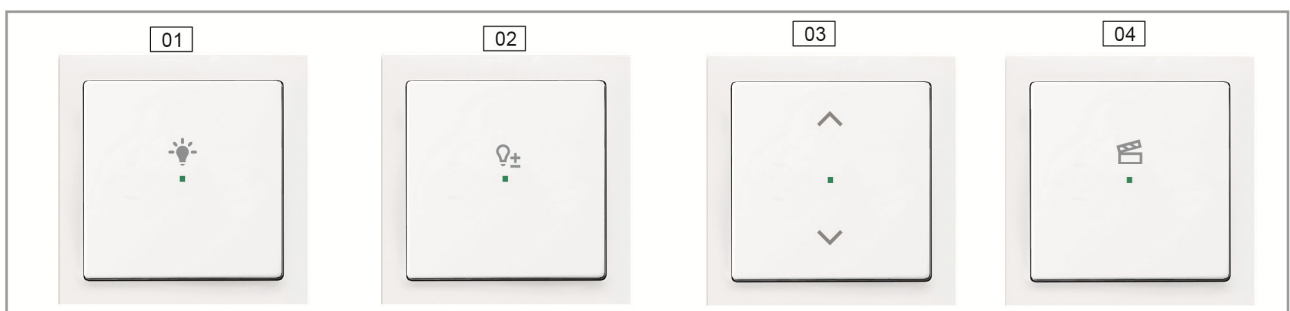



Fig. 30 Rockers for control elements

















- 01 - Light icon
- 02 - Dimmer icon
- 03 - Blind icon
- 04 - Scenes icon

Tab. 5-1 Sensor units

Article number	Product name	Sensor channels	
SU-F-1.0.1	Sensor unit, 1gang	1	
SU-F-2.0.1	Sensor unit, 2gang	2	

Tab. 5-2 Sensor/actuator units

Article number	Product name	Sensor channels	Actuator channels	Switching load
SSA-F-1.1.1	Sensor/switch actuator, 1/1gang	1 	1 	1 x 2300 W
SSA-F-2.1.1	Sensor/switch actuator, 2/1gang	2 	1 	1 x 2300 W
SSA-F-2.2.1	Sensor/switch actuator, 2/2gang	2 	2 	2 x 1200 W
SDA-F-1.1.1	Sensor/dimming actuator, 1/1gang	1 	1 	1 x 180 W
SDA-F-2.1.1	Sensor/dimming actuator, 2/1gang	2 	1 	1 x 180 W
SBA-F-1.1.1	Sensor/blind actuator, 1/1gang	1 	1 	4 A cosφ = 0.5
SBA-F-2.1.1	Sensor/blind actuator, 2/1gang	2 	1 	4 A cosφ = 0.5

Button function (Fig. 31)

All control elements are supplied in "Rocker" operating mode ex factory. This means:

- » Operation on the top activates or gives a movement up command,
- » Operation on the bottom deactivates or gives a movement down command,

The operating mode can also be changed to "Push-button" mode via the channel selection of the respective sensor in the "Device settings". The control element then acts as two separate push-buttons. This means:

- » Operation on top switches on,
- » Repeat of operation on top switches off.

Example of application: The control element is to switch a scene. A scene can only be triggered, but not switched on and off. Through the parameterization as push-button a sensor can activate two different scenes.

Important: The setting becomes visible only after the sensor has been positioned in the allocation.

After the changeover a separate sensor icon is displayed on the floor plan for each of the push-buttons!

LED behaviour of light for orientation

Each rocker of a sensor has an LED. At the point of delivery this LED is configured as light for orientation. This means:

- » The LED lights up permanently, to ensure that the sensor is easy to locate in the dark.

The brightness of the LED can be changed or totally deactivated in the device settings.

LED behaviour for status indication

For the status indication the LED of the rocker can be re-configured in the device settings. If the sensor is linked with an actuator, the LED signals whether the actuator is on or off.

The clear indication of the actuator status is guaranteed as long as only one sensor is linked with one or several actuators or several sensors activate an identical group of actuators (Fig. 32).

If several sensors activate different groups of actuators the correct indication of the actuator status is no longer guaranteed (Fig. 33).

Fig. 31 Button function

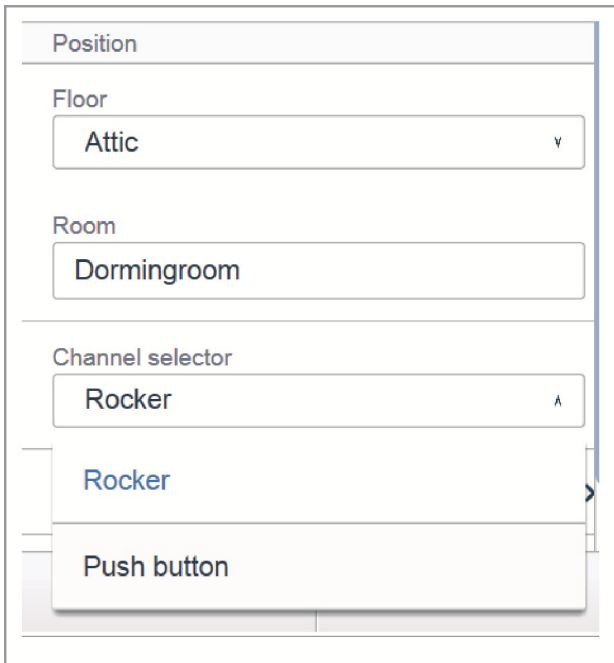

Fig. 32 LED behaviour - status indication possible

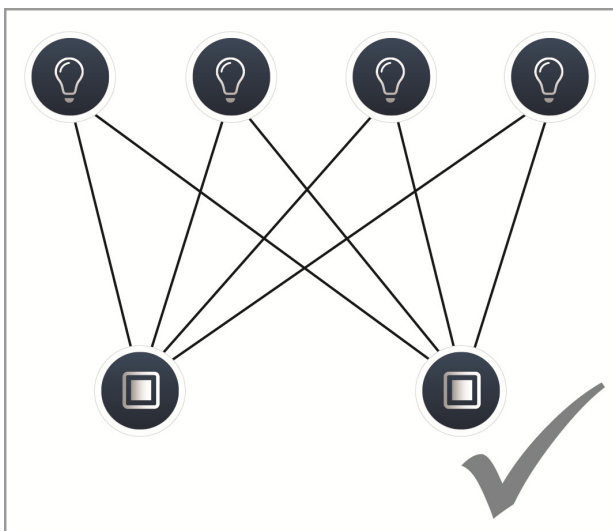
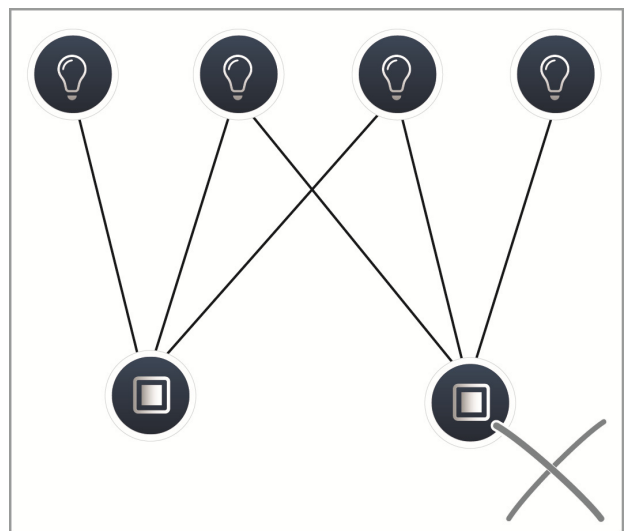
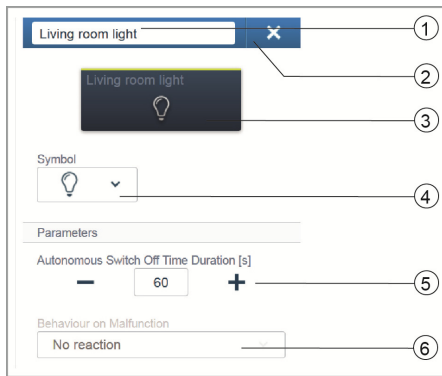

Fig. 33 LED behaviour - status indication not possible



Parameter settings Sensor/switch actuator, 1/1gang

Actuator settings



- [1] Changing the name
- [2] Deleting the channel via 'X'
- [3] Switching of the actuator via the button
- [4] Selection of a different icon
- [5] Setting the switch-off delay in seconds
Buttons -/+ can be used to specify, for example, how long the light remains on after the actuator has deactivated the load.
- [6] Behaviour during faults:
Display of information only! No settings can be made.

Sensor settings



- [1] Changing the name
- [2] Deleting the channel via 'X'
- [3] Selecting the rocker in the list view

Rocker settings

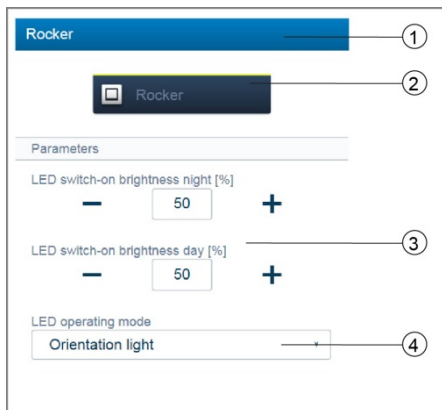

- [1] Changing the name
- [2] Switching the sensor via the button
- [3] Setting the LED night/day switch-on brightness in % via the -/+ buttons:
This parameter can be used to specify how strong the LED lights percentage-wise at night/day.
Attention! The parameter only functions when a time profile with the application "LED day/night switchover" is available. The device (channel) must be linked with this application!
Application symbol: *
- [4] Selecting the LED operating mode:
Light for orientation: LED lights permanent.
Status display: LED lights when actuated.

For pre-programmed devices the following parameter is available immediately. For all other devices it only becomes available after being linked with an actuator. The setting in the list view is then made via the linking function of the Web-based user interface of the System Access Point.



- [5] Selecting the function: Control element; dimming sensor; stairwell light sensor; sensor force-position On/Off; blind sensor; blind force-position

Parameter settings Sensor/switch actuator, 2/1gang

Actuator settings: As for 1/1gang.

Sensor settings: As for 1/1gang; however, 2 rockers (left and right rocker) are displayed in the list view.

Rocker settings: As for 1/1gang; however, the settings can be made for 2 rockers (left and right rocker).

Parameter settings Sensor/switch actuator, 2/2gang

Actuator settings: As for 2/1gang; however, 2 actuator channels are available.

Sensor settings: As for 2/1gang.

Rocker settings: As for 2/1gang.

Parameter settings Sensor/dimming actuator, 1/1gang

Actuator settings

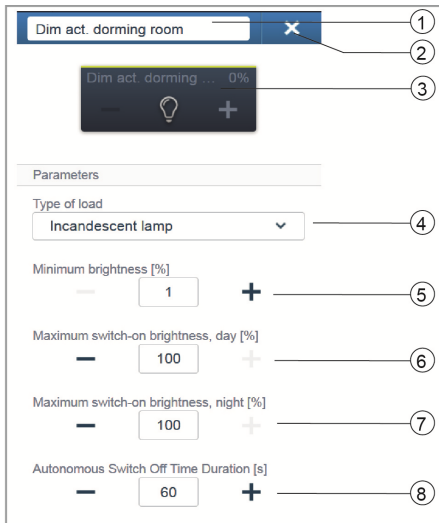

- [1] Changing the name
- [2] Deleting the channel via 'X'
- [3] Switching of the actuator via the button; dimming the actuator via buttons -/+
- [4] Setting of the load connected to the actuator. Selection between:
 - Automatic load detection
 - Inductive load
 - Dimmable LED/KLL
 - Incandescent lamp
- [5] Setting the minimum brightness in % via buttons -/+
- [6] Setting the maximum switch-on brightness during the day in % via buttons -/+
- [7] Setting the maximum switch-on brightness during the night in % via buttons -/+
- [8] Setting the switch-off delay in seconds. Buttons -/+ can be used to specify, for example, how long the light remains on after the actuator has deactivated the load.

Sensor settings

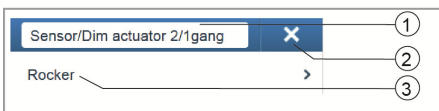

- [1] Changing the name
- [2] Deleting the channel via 'X'
- [3] Selecting the rocker in the list view

Rocker settings

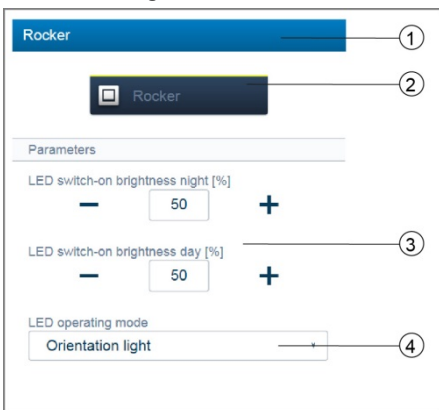

- [1] Changing the name
- [2] Switching the sensor via the button
- [3] Setting the LED night/day switch-on brightness in % via the +/- buttons: This parameter can be used to specify how strong the LED lights percentage-wise at night/day. Attention! The parameter only functions when a time profile with the application "LED day/night switchover" is available. The device (channel) must be linked with this application! Application symbol: *
- [4] Selecting the LED operating mode:
 - Light for orientation: LED lights permanent.
 - Status display: LED lights when actuated.

For pre-programmed devices the following parameter is available immediately. For all other devices it only becomes available after being linked with an actuator. The setting in the list view is then made via the linking function of the Web-based user interface of the System Access Point.



- [5] Selecting the function: Control element; dimming sensor; stairwell light sensor; sensor force-position On/Off; blind sensor; blind force-position

Parameter settings Sensor/dimming actuator, 2/1gang

Actuator settings: As for 1/1gang.

Sensor settings: As for 1/1gang; however, 2 rockers (left and right rocker) are displayed in the list view.

Rocker settings: As for 1/1gang; however, the settings can be made for 2 rockers (left and right rocker).

Parameter settings Sensor/blind actuator, 1/1gang

Actuator settings

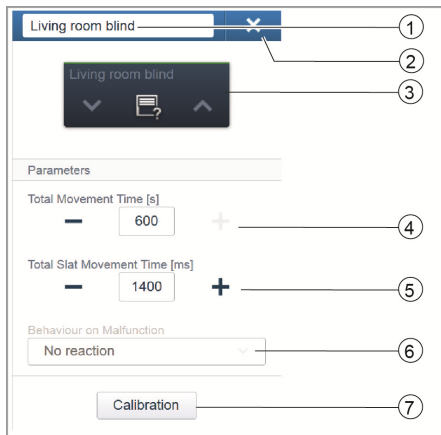

- [1] Changing the name
- [2] Deleting the channel via 'X'
- [3] Switching of the actuator via the button
- [4] Setting the movement time in seconds via buttons -/+
- [5] Setting the movement time of the lamella in seconds via buttons -/+
- [6] Behaviour during faults:
Display of information only! No settings can be made.
- [7] Button "Calibration"
A wizard guides you through the calibration process. For a detailed description see the online Help of the System Access Point.

Sensor settings



- [1] Changing the name
- [2] Deleting the channel via 'X'
- [3] Selecting the rocker in the list view

Rocker settings

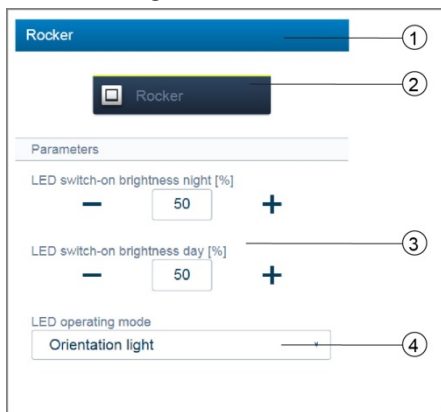

- [1] Changing the name
- [2] Switching the sensor via the button
- [3] Setting the LED night/day switch-on brightness in % via the -/+ buttons:
This parameter can be used to specify how strong the LED lights percentage-wise at night/day.
Attention! The parameter only functions when a time profile with the application "LED day/night switchover" is available. The device (channel) must be linked with this application!
Application symbol: *
- [4] Selecting the LED operating mode:
Light for orientation: LED lights permanent.
Status display: LED lights when actuated.

For pre-programmed devices the following parameter is available immediately. For all other devices it only becomes available after being linked with an actuator. The setting in the list view is then made via the linking function of the Web-based user interface of the System Access Point



- [5] Selecting the function: Control element; dimming sensor; stairwell light sensor; sensor force-position On/Off; blind sensor; blind force-position

Parameter settings Sensor/blind actuator, 2/1gang

Actuator settings: As for 1/1gang.

Sensor settings: As for 1/1gang; however, 2 rockers (left and right rocker) are displayed in the list view.

Rocker settings: As for 1/1gang; however, the settings can be made for 2 rockers (left and right rocker).

Parameter settings Sensor unit, 1gang

Sensor settings

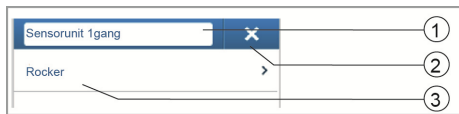

- [1] Changing the name
- [2] Deleting the channel via 'X'
- [3] Selecting the rocker in the list view

Rocker settings

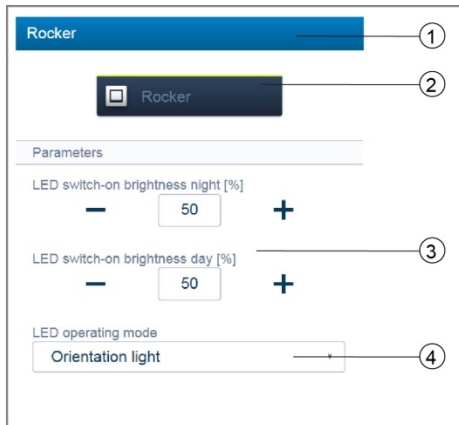

- [1] Changing the name
- [2] Switching the sensor via the button
- [3] Setting the LED night/day switch-on brightness in % via the +/- buttons: This parameter can be used to specify how strong the LED lights percentage-wise at night/day. Attention! The parameter only functions when a time profile with the application "LED day/night switchover" is available. The device (channel) must be linked with this application!
Application symbol: *
- [4] Selecting the LED operating mode:
Light for orientation: LED lights permanent.
Status display: LED lights when actuated.

For pre-programmed devices the following parameter is available immediately. For all other devices it only becomes available after being linked with an actuator. The setting in the list view is then made via the linking function of the Web-based user interface of the System Access Point.



- [5] Selecting the function: Control element; dimming sensor; stairwell light sensor; sensor force-position On/Off; blind sensor; blind force-position

Parameter settings Sensor unit, 2gang

Sensor settings: As for 1gang; however, 2 rockers (left and right rocker) are displayed in the list view.
Rocker settings: As for 1gang; however, the settings can be made for 2 rockers (left and right rocker).

Movement detectors (Fig. 34)

Movement detectors detect movement in their surveillance area and send this information to the free@home bus. This allows automated functions to be executed, e.g. switch a light or a scene.

The movement detector still has a brightness sensor, which measures the ambient brightness. This ensures, for example, that light is switched only when it is actually required. The threshold value from which the movement detector is to switch can be programmed in the user interface.

Detection range: See Fig. 36.

Movement detector (Sensor)

The movement detector (Sensor) serves for the detection of movement, i.e. movements of the user are recorded and sent to the bus.

Remote actuators can be switched via the configuration. Loads can not be switched directly.

Movement detector/actuator unit

Aside from their function as movement detector, movement detector/actuator units also serve as switch for the switching of loads.

The sensors and switching channels are pre-programmed when supplied, i.e. after activating the bus voltage and connecting the load, it is switched directly via the movement detector.

When supplied, the movement detector operates dependent on brightness, i.e. it switches only in the dark. The switching behaviour can be changed in the user interface.

Movement detector order items (Fig. 35)

The scope of delivery of the movement detector contains only the electronic insert. It must still be completed with a frame.

Fig. 34 Movement detector

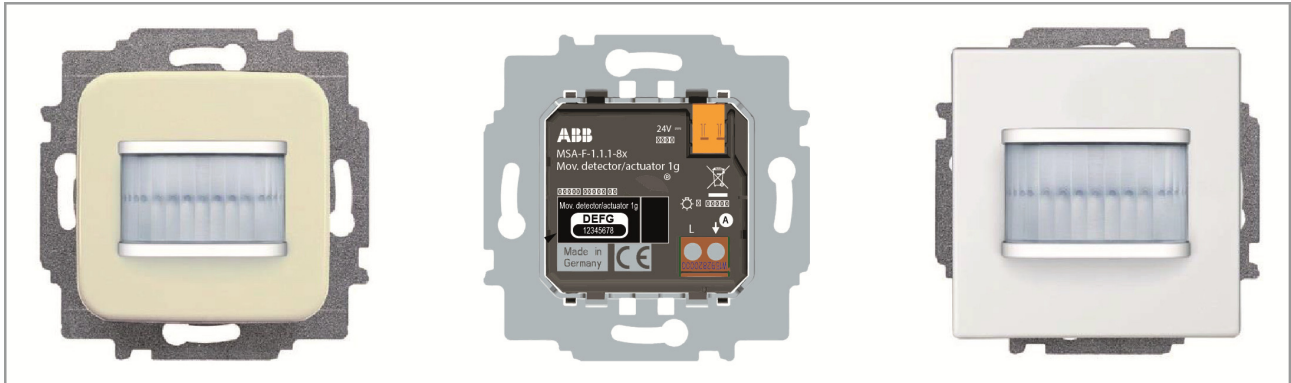

Fig. 35 Movement detector order items

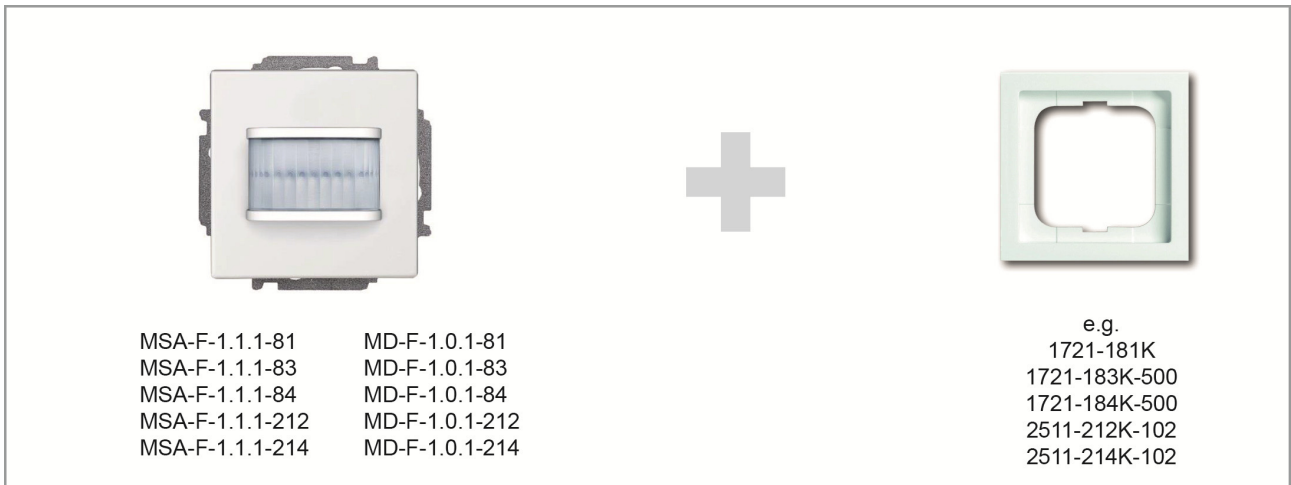
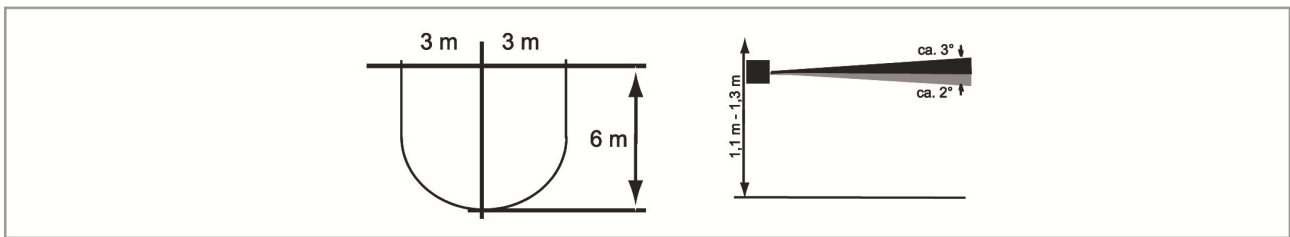

Fig. 36 Detection range



Tab. 5-3 Movement detector (Sensors)

Article number	Product name	Range	Colour	Sensor channels	
MD-F-1.0.1-212	Movement detector	Busch-Duro 2000 SI	White	1	
MD-F-1.0.1-214	Movement detector	Reflex SI	Alpine white	1	
MD-F-1.0.1-81	Movement detector	future® linear/ solo®/ carat®/ Busch-axcent®	Anthracite	1	
MD-F-1.0.1-83	Movement detector	future® linear/ solo®/ carat®/ Busch-axcent®	Aluminium silver	1	
MD-F-1.0.1-84	Movement detector	future® linear/ solo®/ carat®/ Busch-axcent®	Studio white	1	

Tab. 5-4 Movement detector/actuator units

Article number	Product name	Range	Colour	Sensor channels		Actuator channels		Switching load
MSA-F-1.1.1-212	Movement detector/ switch actuator, 1gang	Busch-Duro 2000 SI	White	1		1		1 x 2300 W
MSA-F-1.1.1-214	Movement detector/ switch actuator, 1gang	Reflex SI	Alpine white	1		1		1 x 2300 W
MSA-F-1.1.1-81	Movement detector/ switch actuator, 1gang	future® linear/ solo®/ carat®/ Busch-axcent®	Anthracite	1		1		1 x 2300 W
MSA-F-1.1.1-83	Movement detector/ switch actuator, 1gang	future® linear/ solo®/ carat®/ Busch-axcent®	Aluminium silver	1		1		1 x 2300 W
MSA-F-1.1.1-84	Movement detector/ switch actuator, 1gang	future® linear/ solo®/ carat®/ Busch-axcent®	Studio white	1		1		1 x 2300 W

Parameter settings Movement detector/switch actuator, 1-gang

Actuator settings

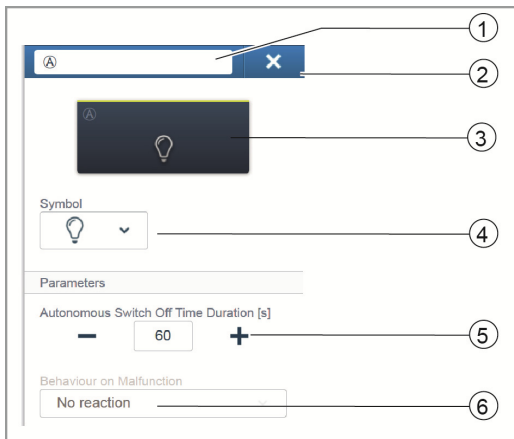

- [1] Changing the name
- [2] Deleting the channel via 'X'
- [3] Switching of the actuator via the button
- [4] Selection of a different icon
- [5] Setting the switch-off delay in seconds
Buttons -/+ can be used to specify, for example, how long the light remains on after the actuator has deactivated the load.
- [6] Behaviour during faults:
Selection of how the device is to respond in case of a fault.

Sensor settings (movement detector settings)

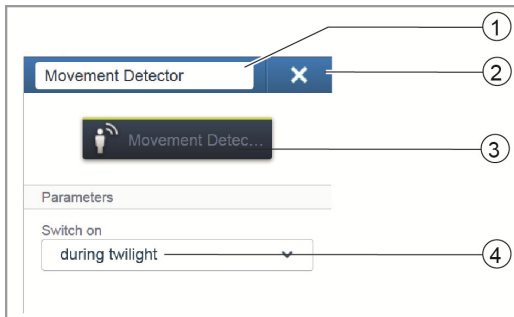

- [1] Changing the name
- [2] Deleting the channel via 'X'
- [3] Switching of the actuator via the button
- [4] Switch-on behavior:
Selection of the brightness conditions at which the device is to respond.

Parameter settings Movement detector (Sensor)

Sensor settings (movement detector settings)

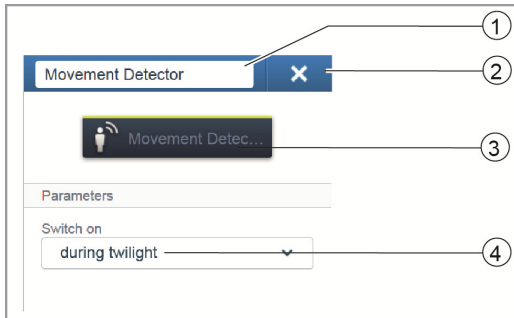

- [1] Changing the name
- [2] Deleting the channel via 'X'
- [3] Switching of the actuator via the button
- [4] Switch-on behavior:
Selection of the brightness conditions at which the device is to respond.

Room temperature controller (Fig. 37)

The display of the room temperature controller always indicates the set-value temperature. This can be changed via the arrow keys of the control element.

The room temperature controller operates as PI controller and in time adjusts its control value also to the response of the room.

The room temperature controller has 4 operating modes that can be adjusted locally:

Comfort operation

Application: You are in the room for a longer period of time; the comfort temperature is to be reached.

Behaviour of the RTC: The display indicates the set-value temperature that has been set. The controller aims at this temperature.

Eco mode

Application: You are leaving the room for a few hours; the room temperature is to be reduced to save energy; however, the room is not to cool down completely.

Behaviour of the RTC: The display indicates "ECO". The temperature is reduced by 4°C (the reduction can be adjusted in the user interface)

Off mode

Application: The room is not being used for a lengthy period of time. Behaviour of RTC: The display indicates "OFF". The heating valves are closed (antifreeze is active).

Antifreeze mode

Application: Switches on automatically when a window contact has been connected and the window is being opened.

Behaviour of the RTC: The display indicates antifreeze. The heating valves close. If the room temperature drops below 7°C, the heating is switched on again to prevent damage to the building.

Heating/cooling switchover

The room temperature controller is suitable both for heating and cooling operation. The switchover of the two modes is made via a binary input which has been configured as heating/cooling reverser and is connected with the room temperature controller in the user interface.

Extension unit operation

The room temperature controller can be configured in the device settings as extension unit. In this setting only the temperature sensor of the main unit is evaluated, the extension unit serves only for selecting the operating mode, and the set-value temperature.

Fig. 37 Room temperature controller

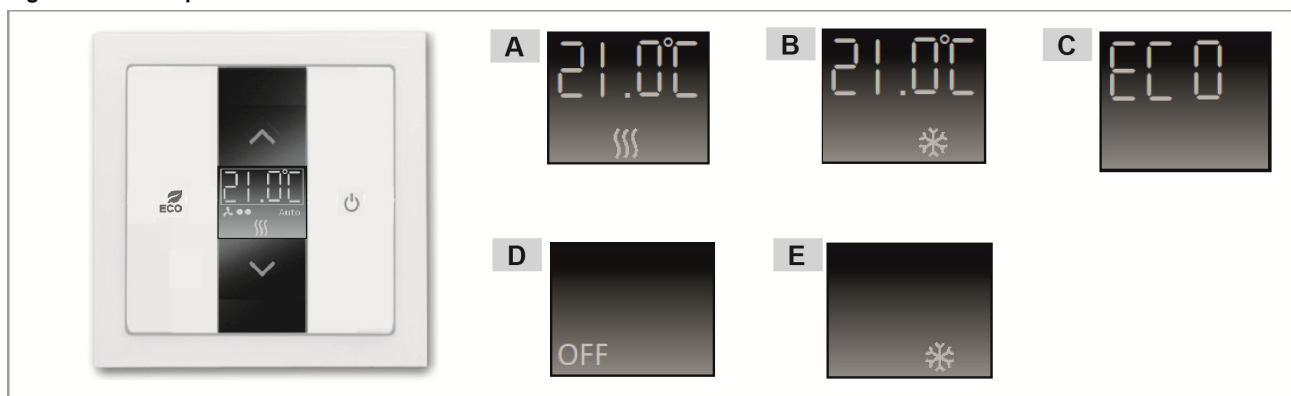

- A - Display of comfort mode heating
- B - Display of comfort mode cooling
- C - Display of ECO mode
- D - Display of OFF mode
- E - Display of antifreeze mode

Tab. 5-5 Room temperature controller

Article number	Product name	Sensor channels	
RTC-F-1	Room temperature controller	1	

Tab. 5-6 Cover plates order items

Article number	Range	Colour
CP-RTC-81	future® linear/ solo®/ carat®/ Busch-axcent®	Anthracite
CP-RTC-83	future® linear/ solo®/ carat®/ Busch-axcent®	Aluminium silver
CP-RTC-84	future® linear/ solo®/ carat®/ Busch-axcent®	Studio white
CP-RTC-212	Reflex SI	White
CP-RTC-214	Reflex SI	Alpine white

Parameter settings of room temperature controller

Actuator settings

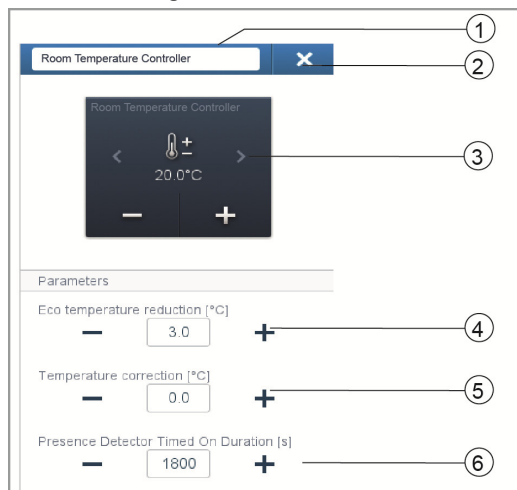

- [1] Changing the name
- [2] Deleting the channel via 'X'
- [3] Switching of the actuator via the button
- [4] Setting the Eco temperature reduction in °C
Specifying the value to which the temperature is reduced after the ECO mode is activated.
- [5] Setting the temperature correction in °C: Manual increase/reduction of the temperature value if the temperature is repeatedly not automatically reached.
- [6] Setting the switch-off delay in seconds during absence
If the ECO mode is deactivated by a movement detector, the switch-off delay can be specified here when the ECO mode is to be re-activated after the room is exited.

Displays

free@home Touch 7" (Fig. 38)

The free@home Touch 7" serves as indoor video station for the ABB-Welcome door communication system and for the central control of free@home functions, such as moving blinds, switching scenes, or controlling room temperature controllers (as extension unit).

The panel is connected to both bus systems, the free@home bus and the Welcome bus. The audio/video signals are transmitted and the device is supplied with power exclusively via the Welcome bus. The panel can therefore also be used as a pure video indoor station without a connection to the free@home system.

It is not possible to operate the panel without being connected to the Welcome bus. This means that at least one ABB-Welcome system controller or one additional power supply is to be provided to ensure that the panel is supplied with power.

Up to 16 free@home functions can be positioned on the free@home operating page. The room temperature controller function occupies two function positions. Programming is carried out via the user interface of the System Access Point.

In addition, the panel acts as gateway which mutually compiles the telegrams of the two bus systems. This, for example, makes it possible to switch an actuator in the free@home system during an incoming door call of the ABB-Welcome system, or to use a sensor in the free@home system to send an "Open door" command to the ABB-Welcome system.

Each of these functions appears as separate entry in the "Allocation" area. The functions can be positioned on the floor plan and then, like any other sensor or actuator, connected in the "Linking" area with other sensors and actuators.

The "Door call" function offers 4 linking functions for each of the 4 possible Welcome outdoor stations. This allows specific actions to be configured separately for each entrance of the house. These are triggered as soon as the visitor rings the bell at one of the outdoor stations.

The "Door opener" function offers 5 connecting functions: Either one of the 4 possible door openers of the Welcome system can be specifically activated (to a open a specific door with the one sensor), or a door opener can be defined which dynamically opens the door from which a door call is currently being made (all doors can be opened with only one sensor, wherever the bell is being rung from).







Icon	Information
	<p>Name: Floor ringing Type: Sensor Made available by: free@homeTouch 7" Function: Signals an incoming floor call (Application: a free@home actuator is to switch during an incoming floor call)</p>
	<p>Name: Floor call button Type: Actuator Made available by: free@homeTouch 7" Function: Triggers a floor call (Application: a free@home sensor is to be used as floor call button)</p>
	<p>Name: Corridor light Type: Actuator Made available by: free@homeTouch 7" Function: Switches the corridor switching contact of the Welcome system controller</p>
	<p>Name: Automatic door opener Type: Actuator Made available by: free@homeTouch 7" Function: Activates/ deactivates the automatic door opener (Application: a free@home sensor is to activate/ deactivate the automatic door opener)</p>
	<p>Name: Door opener Type: Actuator Made available by: free@homeTouch 7" Function: Actuates the door opener of the ABB-Welcome system (Application: a free@home sensor is to activate the door opener)</p>
	<p>Name: Door call Type: Sensor Made available by: free@homeTouch 7" Function: Signals an incoming door call (Application: a free@home actuator is to switch during an incoming door call)</p>

Fig. 38 free@home Touch 7"



Fig. 39 System setup of ABB-free@home® with ABB-Welcome

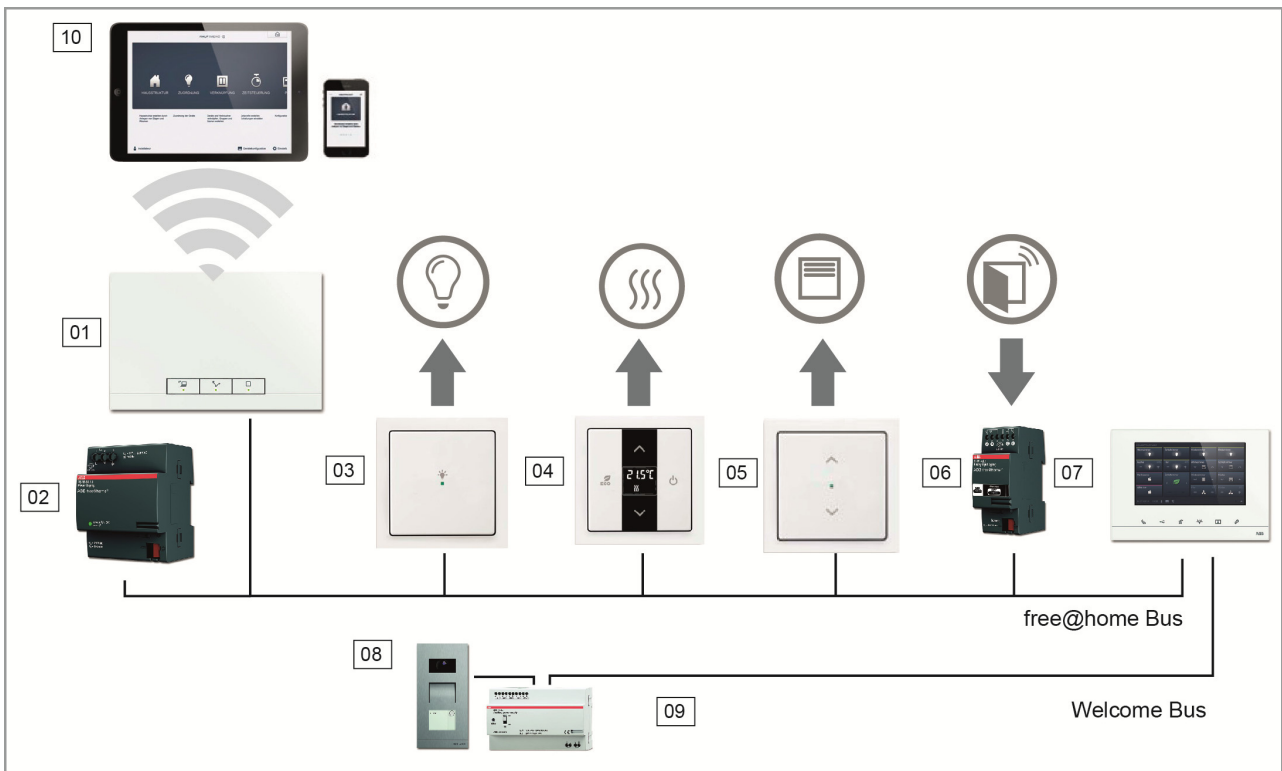

- 01 - System Access Point
- 02 - Power supply free@home bus
- 03 - Sensor/Switch actuator Unit
- 04 - Room temperature controller
- 05 - Sensor/Blind actuator Unit

- 06 - Window contact
- 07 - Panel
- 08 - Outdoor station
- 09 - Power supply Welcome bus
- 10 - Tablet/Smartphone

Tab. 5-7 Displays

Article number	Product name	Colour	Display diagonal
DP7-S-6xx	free@home Touch 7"	White	17.8 cm (7")
DP7-S-6xx	free@home Touch 7"	Black	17.8 cm (7")

Binary inputs (Fig. 40)

With the aid of binary inputs, information of switch contacts can be used outside the free@home system. For example, window contacts can be integrated to switch off the heating in the room automatically or to retract the awning during the wind alarm of a weather station. The type of sensor connected to the binary input must be defined in the user interface.

Each binary input makes the following types of sensors available for selection:

Push-button interface

Integrates a conventional switch or push-button.

Window contact

When connected with a room temperature controller the heating is shut off when the window is open.

Rain alarm

When connected with a blind actuator it retracts the blind/awning at a rain alarm.

Frost alarm

When connected with a blind actuator the blind/awning is moved in/out.

Wind alarm

When connected with a blind actuator the blind/awning is moved in (with wire-break protection, i.e. the wind alarm is triggered when the contact is open).

Cold / warm switchover

When connected with a heating actuator the controller switches between heating and cooling operation.

Fig. 40 Binary inputs

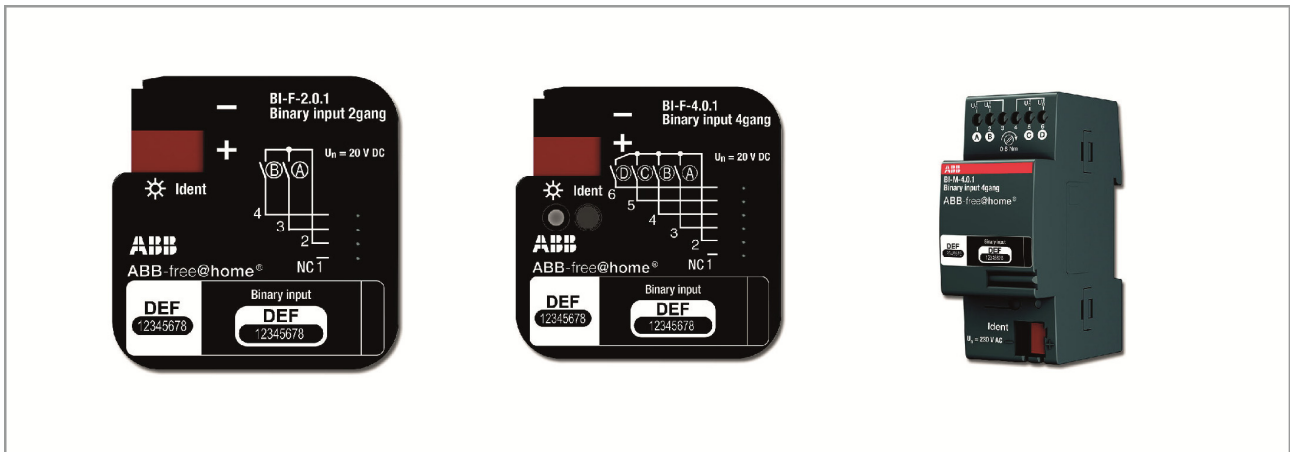

Tab. 5-8 Binary inputs

Article number	Product name	Construction type	Polling Voltage	Input current
BI-F-2.0.1	Binary input, 2gang	Flush mounted pill	20 V =	0.5 mA
BI-F-4.0.1	Binary input, 4gang	Flush mounted pill	20 V =	0.5 mA
BI-M-4.0.1	Binary input, 4gang	MDRC	10-230V =/~	1 mA

Parameter settings

The functions of the binary inputs can be fixed as follows:

- » Control element
- » Dimming sensor
- » Blind sensor
- » Staircase light sensor
- » Frost alarm
- » Force-position sensor On/Off
- » Force-position blind
- » Switchover heating/cooling
- » Wind alarm

Actuators

Switch actuators (Fig. 41)

Switch actuators receive the control commands from sensors and then switch their switching contacts. The actuator can be programmed via the user interface either as individual switching contact or with a timer or a staircase light function.

Dimming actuators (Fig. 42)

Dimming actuators receive the control commands from sensors and then dim their dimming outputs. The dimmer can be programmed via the user interface either as individual switch or with a timer or a staircase light function.

Fig. 41 Switch actuator



Fig. 42 Dimming actuator



Tab. 5-9 Switch actuator

Article number	Product name	Construction type	Input channels	Switching channels	Switching load
SA-M-0.4.1	Switch actuator, 4gang	MDRC	Ø 0	4 	4 x 16 A

Tab. 5-10 Dimming actuator

Article number	Product name	Construction type	Input channels	Switching channels	Switching load
DA-M-0.4.1	Dimming actuator, 4gang	MDRC	Ø 0	4 	4 x 315 W/VA

Parameter settings

Switch actuator

As switch actuators previously described (only 4gang possible).

Dimming actuator

As dimming actuators previously described (only 4gang possible). Channels can be bundled via the device configuration in the System Access Point (only via user access 'Fitter').

Blind actuators (Fig. 43)

Blind actuators receive the control commands from sensors and then switch their switching outputs.

If the blind actuator is linked with a sensor, the blind can be moved with a long press of the button, and the slats adjusted with a brief press of the button.

Wind alarm

As soon as a wind sensor is configured in the system (for description of function see page 50), all blind actuators are coupled to its output signal. This means that during a wind alarm all roller blinds/awnings and blinds move to their top end position and are locked. They can then no longer be moved manually via the control elements. A flashing LED on the control element signals that the blind is locked.

All actuators which are not to respond to the wind alarm can be deactivated via the user interface.

Position fixing/calibrating

Aside from the top/bottom end positions, a blind can also move to intermediate positions, e.g. 50% top. The position is fixed on the basis of the movement time of the blind. Since this movement time varies individually, it must be fixed separately for each blind.

If nothing has been programmed, the visualization cannot display an actual position and only the top/bottom end points can be moved to. The movement time can be set in the device settings of the user interface.

The LED of a sensor, which is connected with a non-calibrated blind, flashes at the point of delivery until the calibration has been carried out.

Heating actuators (Fig. 44)

Heating actuators are suitable for the activation of thermoelectric servo valves. They can only be controlled by room temperature controllers. 3 servo valves share one input voltage terminal. The current via this common terminal must not exceed $I_n=0.5$ A.

Fig. 43 Blind actuator





Fig. 44 Heating actuator



Tab. 5-11 Blind actuator

Article number	Product name	Construction type	Sensor channels	Switching channels	Switching load
BA-M-0.4.1	Blind actuator, 4gang	MDRC	0	4 	4 x 6 A

Tab. 5-11 Heating actuator

Article number	Product name	Construction type	Sensor channels	Switching channels
HA-M-0.6.1	Heating actuator, 6gang	MDRC	0	6 
HA-M-0.12.1	Heating actuator, 12gang	MDRC	0	12 

Parameter settings

Blind actuator

As blind actuators previously described (only 4gang possible).

Heating actuators

The following settings are possible:

1. Function
 - » Valve for heating
 - » Valve for cooling
 - » Valve for heating and cooling
2. Contact type
 - » Opened de-energized
 - » Closed de-energized
3. Specifying the valve opening in % during faults

System Access Point

The System Access Point establishes the connection between the free@home participants and the smartphone, tablet or PC.

It is used to identify and program the participants during commissioning. It also executes time and astro programs and serves as exchange to switch functions via the free@home app.

Identification (Fig. 45)

Devices which are physically connected to the free@home bus, log themselves automatically into the System Access Point. They share information about their type and supported functions. During initial commissioning all devices are given a generic name (Switching actuator 1, etc.). The user then needs to change this name during commissioning to a practical, system-specific name (in the case of an actuator to "Living room light", for example).

Network functions

Access point mode

The access point mode is intended for commissioning of the system. The System Access Point establishes its own WLAN and acts as DHCP server (devices which connect themselves as client with the WLAN receive an IP address automatically).

Advantage: The system can also be made operational and operated without a router (e.g. Fritzbox).

Disadvantage: In access point mode the System Access Point cannot be simultaneously connected to an Internet router. For continuous operation the System Access Point should therefore be configured as LAN or WLAN client so that the users can both surf on the Internet with their devices and operate the free@home system without having to change between different WLAN networks.

- » Press the access point button to activate or deactivate the access point mode.
- » During initial commissioning the access point mode is automatically activated.
- » The network name (SSID), the WLAN password and the IP address of the System Access Point are located on a label in the interior of the device (power adaptor).

LAN / WLAN client mode

If a router is already available it is recommended to connect the System Access Point with this network via LAN or WLAN as client.

The following options are available to activate the client mode:

Connect the System Access Point via LAN with the router before commissioning.

When the cable is plugged in it is recognized automatically and the access point mode is deactivated. The System Access Point then receives an IP address from the router automatically. During the attempt to connect, the connection display flashes. After the connection has been established the connection display lights up permanently.

Connect the System Access Point via LAN with the router after commissioning.

Here the access point mode must be deactivated manually. This can be carried out with a press of the button on the device itself or in the network settings of the user interface. The System Access Point then receives an IP address from the router automatically. During the attempt to connect, the connection display flashes. After the connection has been established the connection display lights up permanently.

Connect the System Access Point via WLAN with the router after commissioning.

This can be carried out via the network settings of the user interface. There select the name* of the network with which you want to connect and enter the network key. The System Access Point then receives an IP address from the router automatically. During the attempt to connect, the connection display flashes. After the connection has been established the connection display lights up permanently.

The access point mode can be activated again at any time. If the access point mode is deactivated, the LAN client or, if it has been configured, the WLAN client mode is activated.

*Note: The list of recommended network names (SSIDs) is created during the boot-up process of the System Access Point. The WLAN networks that cannot be reached at this point will not be shown in the list of recommendations.

Control and display elements

See Fig. 46

Fig. 45 Identification

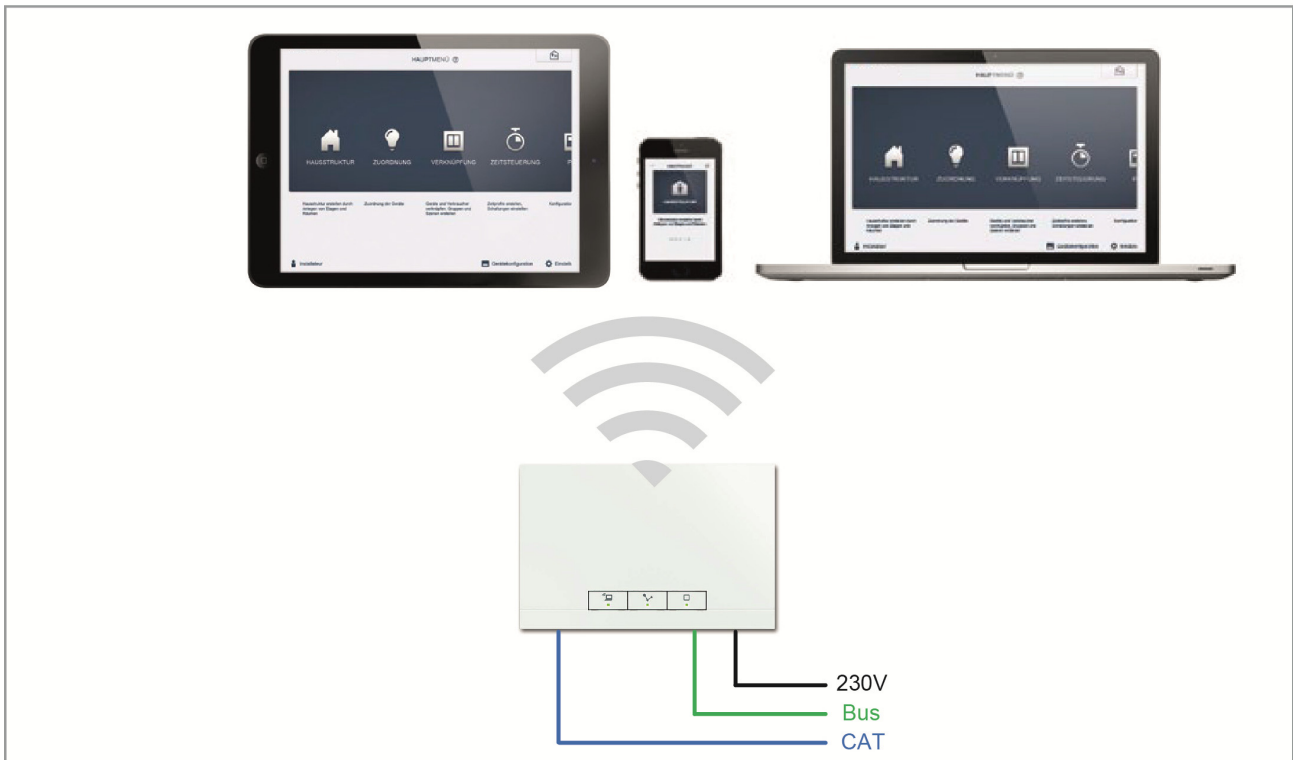
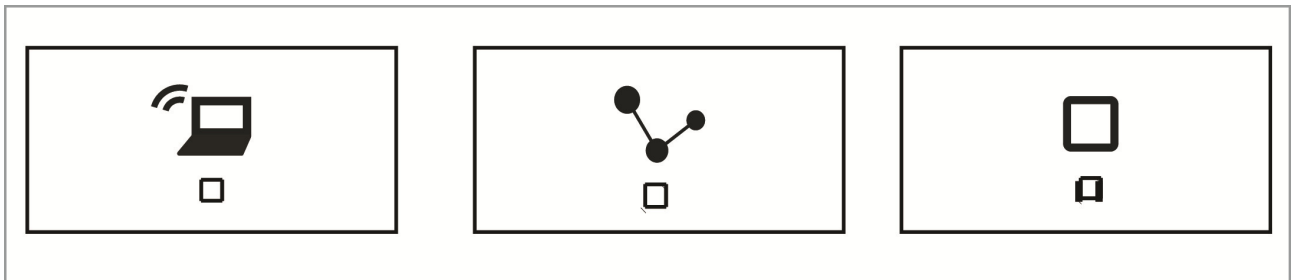

Fig. 46 System Access Point control and display elements



Access point button

Function button:
Button operation switches the access point mode On/Off

LED Status:
On = Access point mode On
Off = Access point mode Off

Connection display

Function button:
No function

LED Status:
On = Connection with LAN/WLAN
OFF = No connection with LAN/WLAN
Flashing = Attempting to connect

Operating display

Function button:
No function

LED Status:
On (50%) = Voltage is applied, device is booting
On = Device is ready for operation
Off = No voltage
Flashing = Fault

Master reset without access to the Web interface

Attention! All data will be lost

A master reset is carried out as follows:

- » Lift the cover off the System Access Point.
- » Briefly press the reset button (above the bus connection terminal).
- » During the boot-up process, which starts now, simultaneous press all three buttons until all three LEDs light up. This can take up to a minute.

The System Access Point is then back to its factory settings.

Additional general settings in the System Access Point**System information**

Current software version status.

Network

Here the network settings of the System Access Point can be programmed.

Possible settings:

- » LAN client - Used when the System Access Point is connected to the Internet router via network cable.
Note: This mode is activated automatically when the access point mode is deactivated (LED of the left button is off).
- » WLAN client - Used when the System Access Point is connected to the Internet router via WLAN.

User

Her additional users can be created or users deleted. Also access rights can be changed.

General

Setting of the system name, the system language, location and time.

Data backup

The data backup stores all the settings made. It is first backed up on the internal memory of the System Access Point, but it can also be exported. The data backup is created automatically at regular intervals, but it can also be created manually. Data backups that have been created by user type "Fitter", can be restored by other users, but cannot be deleted by them.

Update

Firmware update of the System Access Point and the free@home devices. The update file contains both the updates of the System Access Point as well as the updates for all system devices. The update consists of four steps:

1. Upload of the firmware to the System Access Point: Takes place automatically after the update file has been selected.
2. Processing the firmware: Takes place automatically after the successful update. The process can take a few minutes.
3. Installing the firmware: Takes place after confirming the update dialogue. The update takes a few minutes. After the update has been carried out successfully, the System Access Point restarts. This could lead to the website in the Internet browser continuing to indicate an ongoing update process. An update of the website (F5 key) rectifies the problem.
4. Firmware update of all free@home devices connected to the bus: After confirming the update dialogue, all free@home devices connected to the bus are updated automatically. The update is always carried out simultaneously on two devices and can be recognized by the mutual flashing of the LEDs. The process takes approximately 2 minutes for each device. The system can be operated as usual during the update.











Service



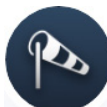



Updating all devices: Loads the current firmware to the free@home devices. Only necessary if the update of the devices was rejected during the update dialogue.

Master reset: Resets all free@home devices connected to the bus to the factory settings. All data backups, user data, floor plans and time programs are retained.

Resetting the database: Resets the System Access Point completely or partly to the factory settings. The selection of the parameters to be reset is made in the pop-up window



06 Device Functions

Symbol	Informationen	Symbol	Informationen
	<p>Name: Sensor Type: Sensor Made available by: Sensor unit; sensor/switch actuator; sensor/dimming actuator; sensor/blind actuator; Function: Control element for the control of free@home functions</p>		<p>Name: Blind actuator Type: Actuator Made available by: Blind actuator; sensor/blind actuator Function: Moves connected blinds and roller blinds</p>
	<p>Name: Movement detector Type: Sensor Made available by: Movement detector; movement detector/switch actuator Function: Sensor for movement- and brightness-dependent control of free@home functions</p>		<p>Name: Heating actuator Type: Actuator Made available by: Heating actuator; sensor/blind actuator Function: Moves connected blinds and roller blinds</p>
	<p>Name: Room temperature controller Type: Sensor Made available by: Room temperature controller Function: Controls free@home heating actuators</p>		<p>Name: Wind alarm Type: Sensor Made available by: Binary input Function: Triggers a wind alarm (Application: automatic retraction of blinds)</p>
	<p>Name: Panel Type: Sensor Made available by: free@home Touch 7" Function: The location for installation and name of the panel can be changed</p>		<p>Name: Window contact Type: Sensor Made available by: Binary input Function: Signals 'window open' (Application: automatic deactivation of heating when the window is open)</p>
	<p>Name: Switch actuator Type: Actuator Made available by: Switch actuator; sensor/switch actuator; movement detector/switch actuator Function: Switches connected loads</p>		<p>Name: Rain alarm Type: Sensor Made available by: Binary input Function: Triggers a rain alarm (Application: automatic retraction of awning)</p>
	<p>Name: Dimming actuator Type: Actuator Made available by: Dimming actuator; sensor/dimming actuator Function: Dims connected loads</p>		<p>Name: Frost alarm Type: Sensor Made available by: Binary input Function: Triggers a frost alarm (Application: automatic retraction of awning)</p>

Symbol	Informationen	Symbol	Informationen
	<p>Name: Switchover heating/cooling Type: Sensor Made available by: Binary input Function: Switches the room temperature controller over between heating mode and cooling mode</p>		<p>Name: Door call Type: Sensor Made available by: free@homeTouch 7" Function: Signals an incoming door call (Application: a free@home actuator is to switch during an incoming door call)</p>
	<p>Name: Floor ringing Type: Sensor Made available by: free@home Touch 7" Function: Signals an incoming floor call (Application: a free@home actuator is to switch during an incoming floor call)</p>		<p>Name: Automatic door opener Type: Actuator Made available by: free@home Touch 7" Function: Activates/ deactivates the automatic door opener (Application: a free@home sensor is to activate/deactivate the automatic door opener)</p>
	<p>Name: Floor call button Type: Actuator Made available by: free@home Touch 7" Function: Triggers a floor call (Application: a free@home sensor is to be used as floor call button)</p>		<p>Name: Corridor light Type: Actuator Made available by: free@home Touch 7" Function: Switches the corridor switching contact of the Welcome system controller</p>
	<p>Name: Door opener Type: Actuator Made available by: free@home Touch 7" Function: Actuates the door opener of the ABB-Welcome system (Application: a free@home sensor is to actuate the door opener)</p>		

07 Overview of Product Range

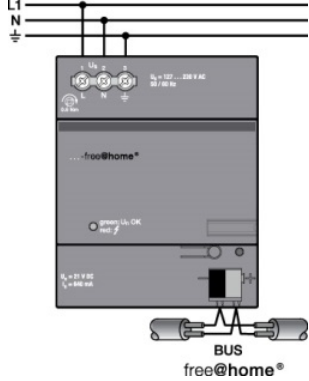

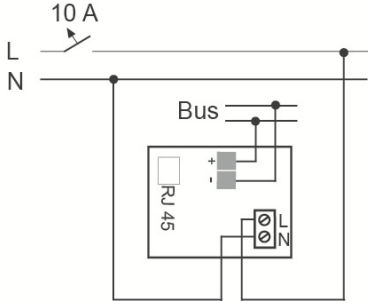

System devices

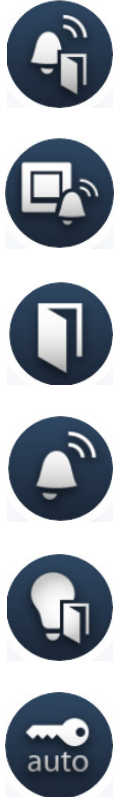
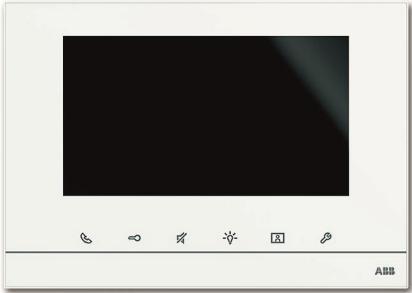
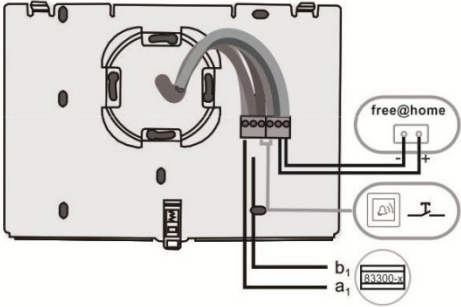

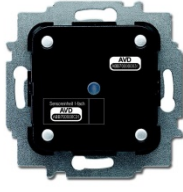
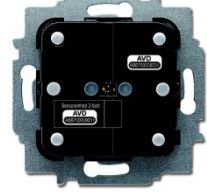
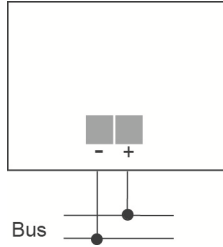

Power supply		
	 <p data-bbox="596 869 727 922">PS-M-64.1.1 640 mA</p>	
System Access Point		
	 <p data-bbox="603 1391 727 1413">SAP-S-1-84</p>	

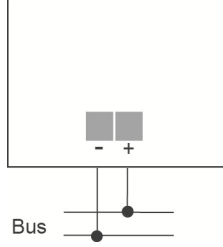
Displays

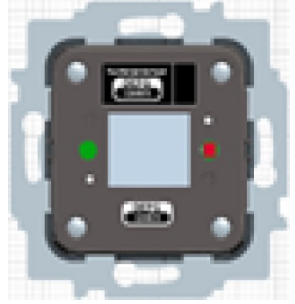
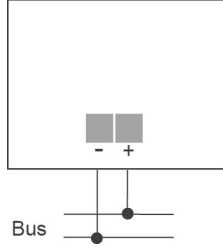

Touch 7"		
	 <p data-bbox="485 1061 767 1133">DP7-S-6xx 16 ABB-free@home buttons ABB-Welcome</p>	

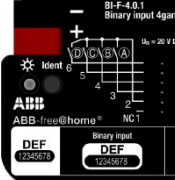
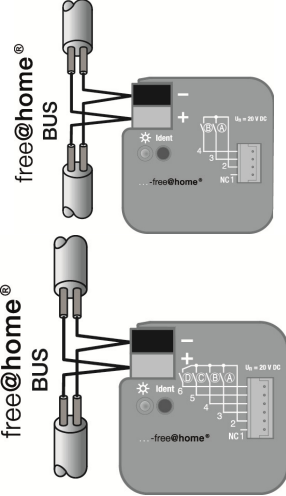

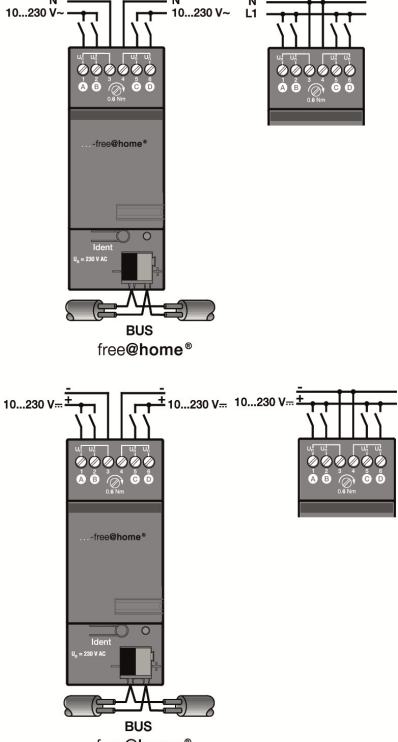

Sensors



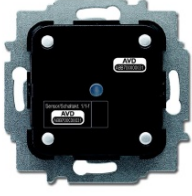
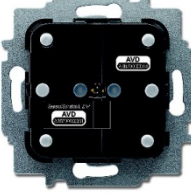
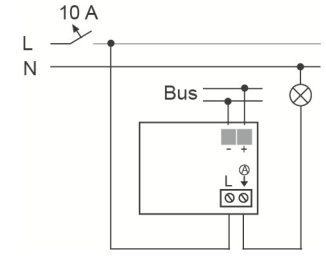
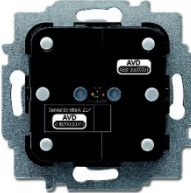
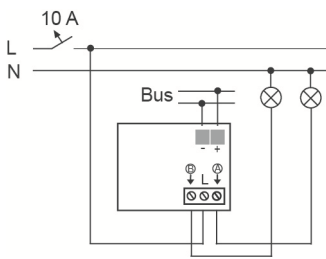

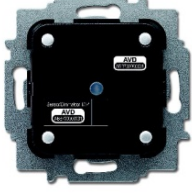

Sensor units	1gang	2gang	
	 <p>SU-F-1.0.1</p>	 <p>SU-F-2.0.1</p>	 <p>Bus</p>
Movement detector	1gang		
	 <p>MD-F-1.0.1...</p>		 <p>Bus</p>
Temperature control	Room temperature controller		
	 <p>RTC-F-1</p>		 <p>Bus</p>

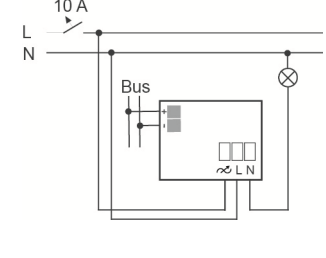
Binary inputs	2gang	4gang	
	 <p data-bbox="395 678 571 723">BI-F-2.0.1 20V DC = 0,5 mA</p>	 <p data-bbox="675 678 850 723">BI-F-4.0.1 20V DC = 0,5 mA</p>	
	<p data-bbox="467 1272 499 1283">---</p>	 <p data-bbox="691 1361 850 1429">BI-M-4.0.1 10-230V DC/AC ≈/~ 1 mA</p>	



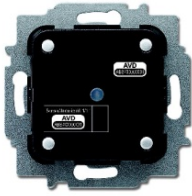
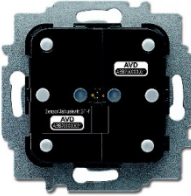
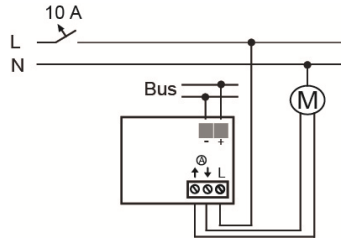

Sensor/actuator units

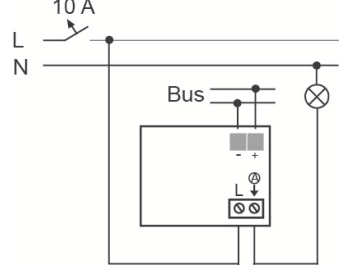

Sensor/ switch actuator		1gang sensor	2gang sensor	
 	1gang actuator	 SSA-F-1.1.1 1 x 2300W	 SSA-F-2.1.1 1 x 2300W	
	2gang actuator	---	 SSA-F-2.2.1 2 x 1200W	

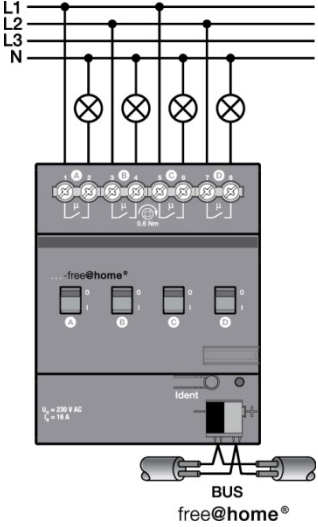

Sensor/dimming actuator		1gang sensor	2gang sensor	
 	1gang actuator	 SDA-F-1.1.1 1 x 180 W/VA	 SDA-F-2.1.1 1 x 180 W/VA	

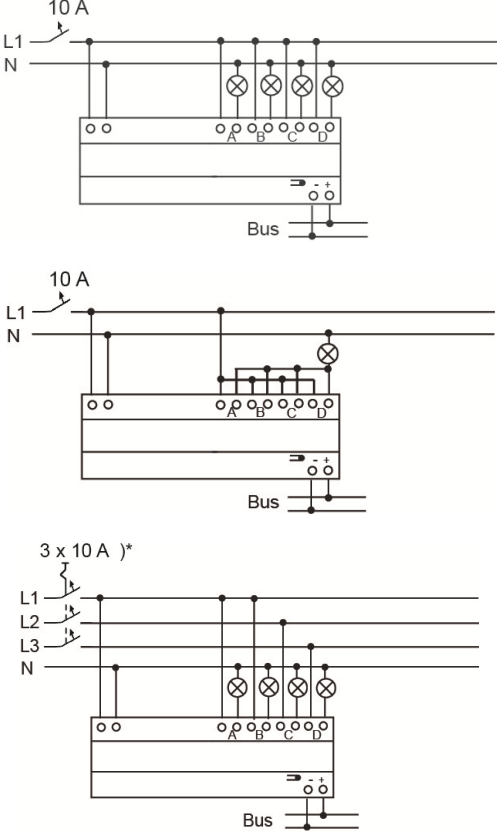
Sensor/ blind actuator		1gang sensor	2gang sensor	
 	1gang actuator	 SBA-F-1.1.1 4A, cos φ =0,5	 SBA-F-2.1.1 4A, cos φ =0,5	
Movement detector/ Switch actuator		1gang sensor		
 	1gang actuator	 MSA-F-1.1.1... 1 x 2300W		

Actuators

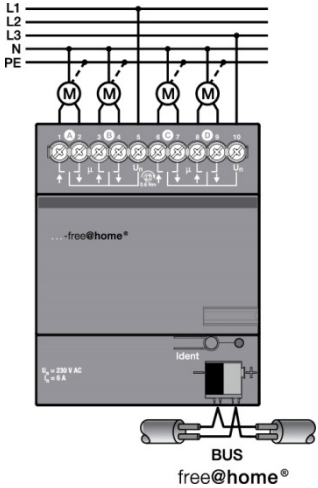
Switch actuators	4gang	
	 <p data-bbox="568 757 687 801">SA-M-0.4.1 4 x 16 A</p>	 <p data-bbox="1193 837 1305 869">BUS free@home®</p>
Dimming actuator	4gang	
	 <p data-bbox="555 1576 699 1621">DA-M-0.4.1 4 x 315 W/VA</p>	

Blind actuator	4gang		
	 <p data-bbox="568 730 683 779">BA-M-0.4.1 4 x 6 A</p>		

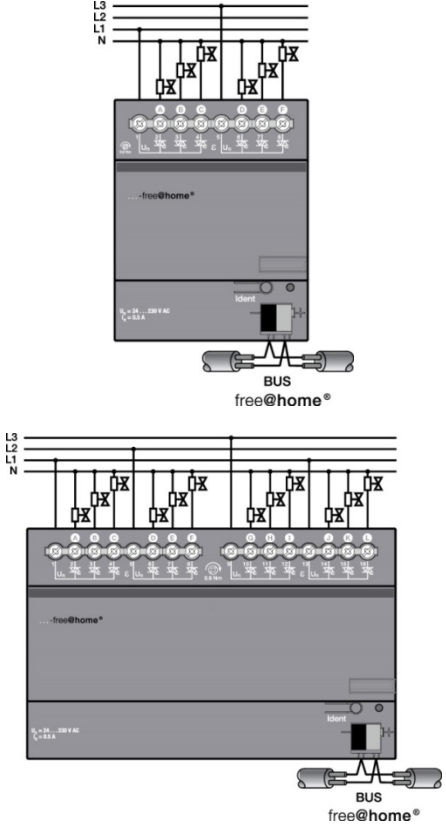
Heating actuator	6gang	12gang	
	 <p data-bbox="395 1469 507 1491">HA-M-0.6.1</p>	 <p data-bbox="675 1469 802 1491">HA-M-0.12.1</p>	

Covers for switch ranges

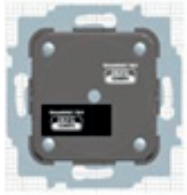

SU-F-1.0.1
SSA-F-1.1.1
SDA-F-1.1.1
SBA-F-1.1.1

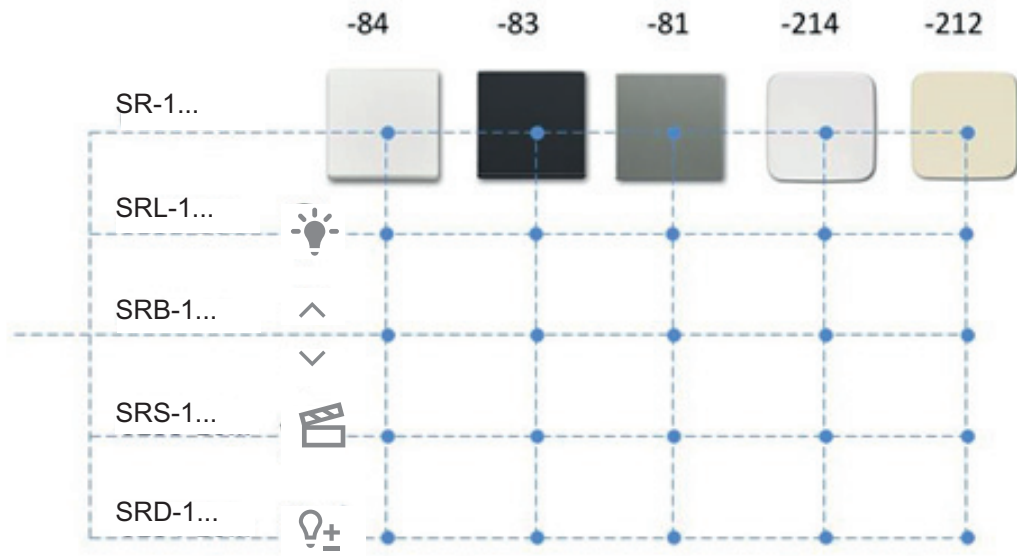

SU-F-2.0.1
SSA-F-2.1.1
SSA-F-2.2.1
SDA-F-2.1.1
SBA-F-2.1.1

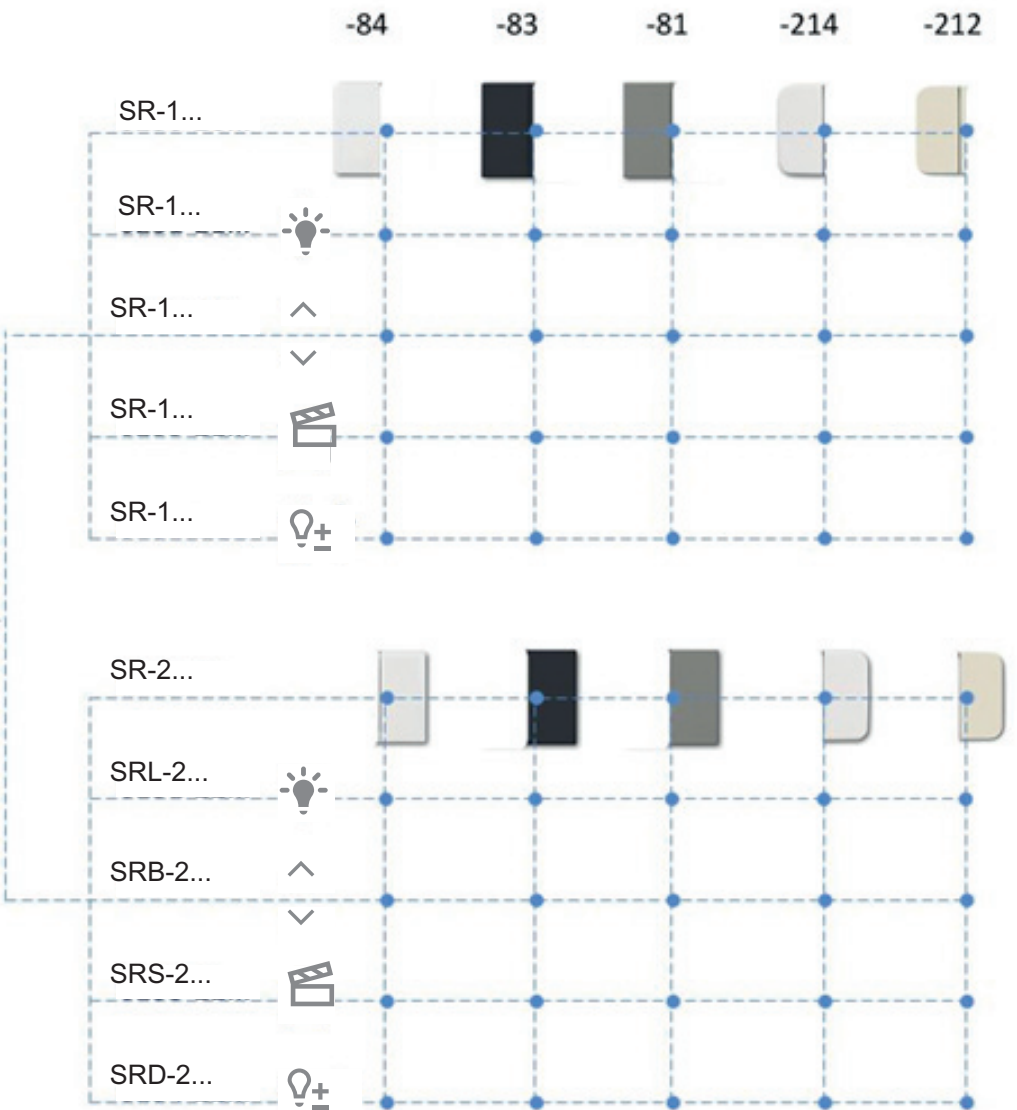

Article number	Printing	Version	Orientation	Range	Colour
SR-1-81	-	1gang	-	solo/ future/ carat/ axcent	Anthracite
SR-1-83	-	1gang	-	solo/ future/ carat/ axcent	Aluminium silver
SR-1-84	-	1gang	-	solo/ future/ carat/ axcent	Studio white
SRL-1-81	Light	1gang	-	solo/ future/ carat/ axcent	Anthracite
SRL-1-83	Light	1gang	-	solo/ future/ carat/ axcent	Aluminium silver
SRL-1-84	Light	1gang	-	solo/ future/ carat/ axcent	Studio white
SRB-1-81	Blind	1gang	-	solo/ future/ carat/ axcent	Anthracite
SRB-1-83	Blind	1gang	-	solo/ future/ carat/ axcent	Aluminium silver
SRB-1-84	Blind	1gang	-	solo/ future/ carat/ axcent	Studio white
SRS-1-81	Scene	1gang	-	solo/ future/ carat/ axcent	Anthracite
SRS-1-83	Scene	1gang	-	solo/ future/ carat/ axcent	Aluminium silver
SRS-1-84	Scene	1gang	-	solo/ future/ carat/ axcent	Studio white
SRD-1-81	Dimmer	1gang	-	solo/ future/ carat/ axcent	Anthracite
SRD-1-83	Dimmer	1gang	-	solo/ future/ carat/ axcent	Aluminium silver
SRD-1-84	Dimmer	1gang	-	solo/ future/ carat/ axcent	Studio white
SR-2-81	-	2gang	-	solo/ future/ carat/ axcent	Anthracite
SR-2-83	-	2gang	-	solo/ future/ carat/ axcent	Aluminium silver
SR-2-84	-	2gang	-	solo/ future/ carat/ axcent	Studio white
SRL-2-L-81	Light	2gang	Left	solo/ future/ carat/ axcent	Anthracite
SRL-2-L-83	Light	2gang	Left	solo/ future/ carat/ axcent	Aluminium silver
SRL-2-L-84	Light	2gang	Left	solo/ future/ carat/ axcent	Studio white
SRB-2-81	Blind	2gang	-	solo/ future/ carat/ axcent	Anthracite
SRB-2-83	Blind	2gang	-	solo/ future/ carat/ axcent	Aluminium silver
SRB-2-84	Blind	2gang	-	solo/ future/ carat/ axcent	Studio white
SRS-2-L-81	Scene	2gang	Left	solo/ future/ carat/ axcent	Anthracite
SRS-2-L-83	Scene	2gang	Left	solo/ future/ carat/ axcent	Aluminium silver
SRS-2-L-84	Scene	2gang	Left	solo/ future/ carat/ axcent	Studio white
SRD-2-L-81	Dimmer	2gang	Left	solo/ future/ carat/ axcent	Anthracite
SRD-2-L-83	Dimmer	2gang	Left	solo/ future/ carat/ axcent	Aluminium silver
SRD-2-L-84	Dimmer	2gang	Left	solo/ future/ carat/ axcent	Studio white
SRL-2-R-81	Light	2gang	Right	solo/ future/ carat/ axcent	Anthracite
SRL-2-R-83	Light	2gang	Right	solo/ future/ carat/ axcent	Aluminium silver
SRL-2-R-84	Light	2gang	Right	solo/ future/ carat/ axcent	Studio white
SRS-2-R-81	Scene	2gang	Right	solo/ future/ carat/ axcent	Anthracite
SRS-2-R-83	Scene	2gang	Right	solo/ future/ carat/ axcent	Aluminium silver
SRS-2-R-84	Scene	2gang	Right	solo/ future/ carat/ axcent	Studio white
SRD-2-R-81	Dimmer	2gang	Right	solo/ future/ carat/ axcent	Anthracite
SRD-2-R-83	Dimmer	2gang	Right	solo/ future/ carat/ axcent	Aluminium silver
SRD-2-R-84	Dimmer	2gang	Right	solo/ future/ carat/ axcent	Studio white
SR-1-212	-	1gang	-	Busch-Duro 2000 SI	White
SR-1-214	-	1gang	-	Reflex SI	Alpine white
SRL-1-212	Light	1gang	-	Busch-Duro 2000 SI	White
SRL-1-214	Light	1gang	-	Reflex SI	Alpine white
SRB-1-212	Blind	1gang	-	Busch-Duro 2000 SI	White
SRB-1-214	Blind	1gang	-	Reflex SI	Alpine white
SRS-1-212	Scene	1gang	-	Busch-Duro 2000 SI	White
SRS-1-214	Scene	1gang	-	Reflex SI	Alpine white
SRD-1-212	Dimmer	1gang	-	Busch-Duro 2000 SI	White
SRD-1-214	Dimmer	1gang	-	Reflex SI	Alpine white
SR-2-212	-	2gang	-	Busch-Duro 2000 SI	White
SR-2-214	-	2gang	-	Reflex SI	Alpine white
SRL-2-L-212	Light	2gang	Left	Busch-Duro 2000 SI	White
SRL-2-L-214	Light	2gang	Left	Reflex SI	Alpine white
SRB-2-212	Blind	2gang	Left	Busch-Duro 2000 SI	White
SRB-2-214	Blind	2gang	Left	Reflex SI	Alpine white
SRS-2-L-212	Scene	2gang	Left	Busch-Duro 2000 SI	White
SRS-2-L-214	Scene	2gang	Left	Reflex SI	Alpine white
SRD-2-L-212	Dimmer	2gang	Left	Busch-Duro 2000 SI	White
SRD-2-L-214	Dimmer	2gang	Left	Reflex SI	Alpine white
SRL-2-R-212	Light	2gang	Right	Busch-Duro 2000 SI	White
SRL-2-R-214	Light	2gang	Right	Reflex SI	Alpine white
SRS-2-R-212	Scene	2gang	Right	Busch-Duro 2000 SI	White
SRS-2-R-214	Scene	2gang	Right	Reflex SI	Alpine white
SRD-2-R-212	Dimmer	2gang	Right	Busch-Duro 2000 SI	White
SRD-2-R-214	Dimmer	2gang	Right	Reflex SI	Alpine white
CP-RTC-81	Room temperature controller	-	-	solo/ future/ carat/ axcent	Anthracite
CP-RTC-83	Room temperature controller	-	-	solo/ future/ carat/ axcent	Aluminium silver
CP-RTC-84	Room temperature controller	-	-	solo/ future/ carat/ axcent	Studio white
CP-RTC-212	Room temperature controller	-	-	Busch-Duro 2000 SI	White
CP-RTC-214	Room temperature controller	-	-	Reflex SI	Alpine white

08 FAQ und Tipps

Mounting the System Access Point (Fig. 47)

The System Access Point is installed surface-mounted. The bus line is always inserted on the rear side. The 230 V power cord and the optional CAT wire can also be inserted on the rear side or installed surface-mounted. In case of surface-mounting, the wires are inserted from the underside of the device via the available breakout openings.

If the CAT wire is inserted on the rear side, it should be ensured that the distance between centres of the two installation boxes amounts to 80 mm.

Connection of the CAT wire

CAT wires that are already patched can be connected directly via the RJ45 female connector of the System Access Point.

If an installation line is being used, the adapter cable enclosed with the device is to be used. On one end of this cable the installation cable can be installed via LSA technology. On the other end is an RJ45 plug, which can be connected with the female connector of the System Access Point.

Commissioning is always carried out via the System Access Point. A smartphone, tablet or PC is required for commissioning. No additional software is required. The use of the free-of-charge free@home® app is recommended for commissioning via smartphone or tablet.

Fig. 47 Mounting the System Access Point

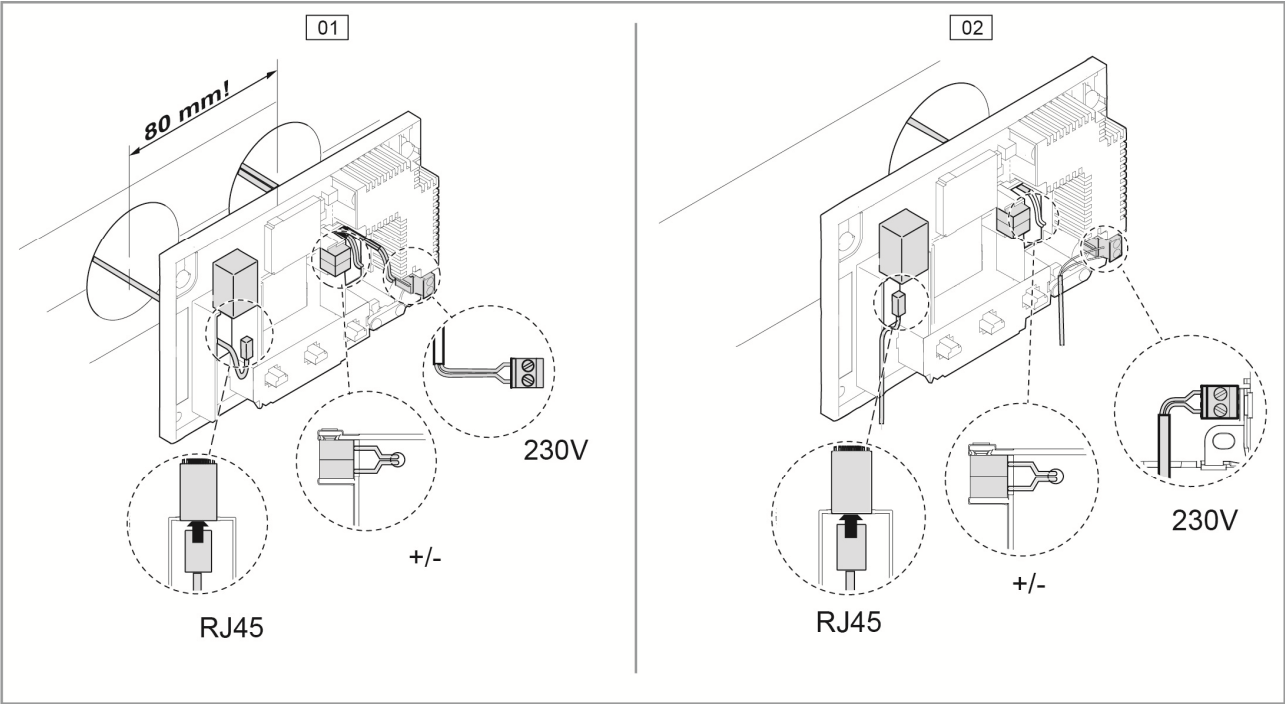

01 - CAT-wire inserted in rear side
02 - CAT-wire installed surface-mounted

Device plan master

Fig. 48 device plan

	MOUNTING PLACE	CHANNEL	FUNCTION	ROOM
		○		
		○		
		○		
		○		
		○		
		○		
		○		
		○		
		○		
		○		
		○		
		○		
		○		
		○		
		○		
		○		
		○		
		○		
		○		
		○		
		○		
		○		
		○		
		○		
		○		
		○		
		○		

Contact us

A member
of the ABB Group

Busch-Jaeger Elektro GmbH
P.O. Box
58505 Lüdenscheid
Germany

Freisenbergstraße 2
58513 Lüdenscheid
Germany

www.BUSCH-JAEGER.com
info.bje@de.abb.com

Central sales service:

Phone +49 2351 956-1600
Fax +49 2351 956-1700

Note:

Reprinting and photomechanical reproduction is permitted only with our express approval.

The printed material from Busch-Jaeger to the best of our knowledge informs; it is, however, not legally binding. All illustrations and photos of the displayed products are not binding with regard to chromaticity, dimensions and equipment.

The majority of Busch-Jaeger products are registered trademarks.

All information in this catalogue is supplied without liability. Changes and updates which serve the purpose of progress are reserved.

All products in this printed material, which conform to CE directives, carry the appropriate identification on the package or on the product.