

Conduit Systems - Interfaces



AMP Junior & Mini Hinged Connector Interface

SPECIALIST CONDUIT SYSTEMS

Technical Characteristics

Conforms to	CE Mark to the low voltage directive RoHS Compliant to 2011/65/EU Conforms with end of life vehicle directive (ELV)EU200/53/EC	
Approvals and Standards		
Degree of mechanical protection	Medium	
Degree of protection	IP40 - Hinged Connector Interface fittings	
UV protection	Very High (Black)	
Finish	Black (BL)	
Application	Single junction straight and 90° elbow fittings providing high integrity connections between AMP Junior & mini timer connectors and Harnessflex conduit systems. In addition, 90° elbow versions allow the conduit to swivel 360° around the connector housing, sufficient to avoid the problems associated with one-piece interfaces of overflexing due to movement or vibration.	
Normal operating temperature range	Minimum Temperature	Maximum Temperature
	- 40°C	+120°C
For use with - Conduit range	For use with all Conduits in the Harnessflex range	
Fire performance	Self Extinguishing Low smoke toxicity & Halogen Free	
Chemical resistance & Storage data	Click or See page 4	
Type of material	Polyamide (Nylon) PA 66 - heat and UV stabilised	

Image



Conduit Systems - Interfaces



AMP Junior & Mini Hinged Connector Interface

SPECIALIST CONDUIT SYSTEMS

Dimensional Data

Part No Straight Interface	Conduit Size		Dimensions				Connector Reference
	(NC)	(NW)	A	B	C	D	
CI08-AM2	08	7.5	24.9	21.3	18	10	AMP Junior timer 2-way
CI08-AM3	08	7.5	24.9	27.2	18	10	AMP Junior timer 3-way
CI08-AM4	08	7.5	37.0	32.0	19	10	AMP Junior timer 4-way
CI10-AM2	10	8.5	37.0	21.0	19	10	AMP Junior timer 2-way
CI10-AM3	10	8.5	37.0	27.0	19	10	AMP Junior timer 3-way
CI10-AM4	10	8.5	37.0	32.0	19	10	AMP Junior timer 4-way
CI12-AM2	12	10	24.9	21.3	18	10	AMP Junior timer 2-way
CI12-AM3	12	10	24.9	27.2	18	10	AMP Junior timer 3-way
CI12-AM4	12	10	37.0	32.0	19	10	AMP Junior timer 4-way

Part No Straight Interface	Conduit Size		Dimensions				Connector Reference
	(NC)	(NW)	A	B	C	D	
CI12-X01	12	10	34	16.2	19.6	10	AMP Mini timer 1-way

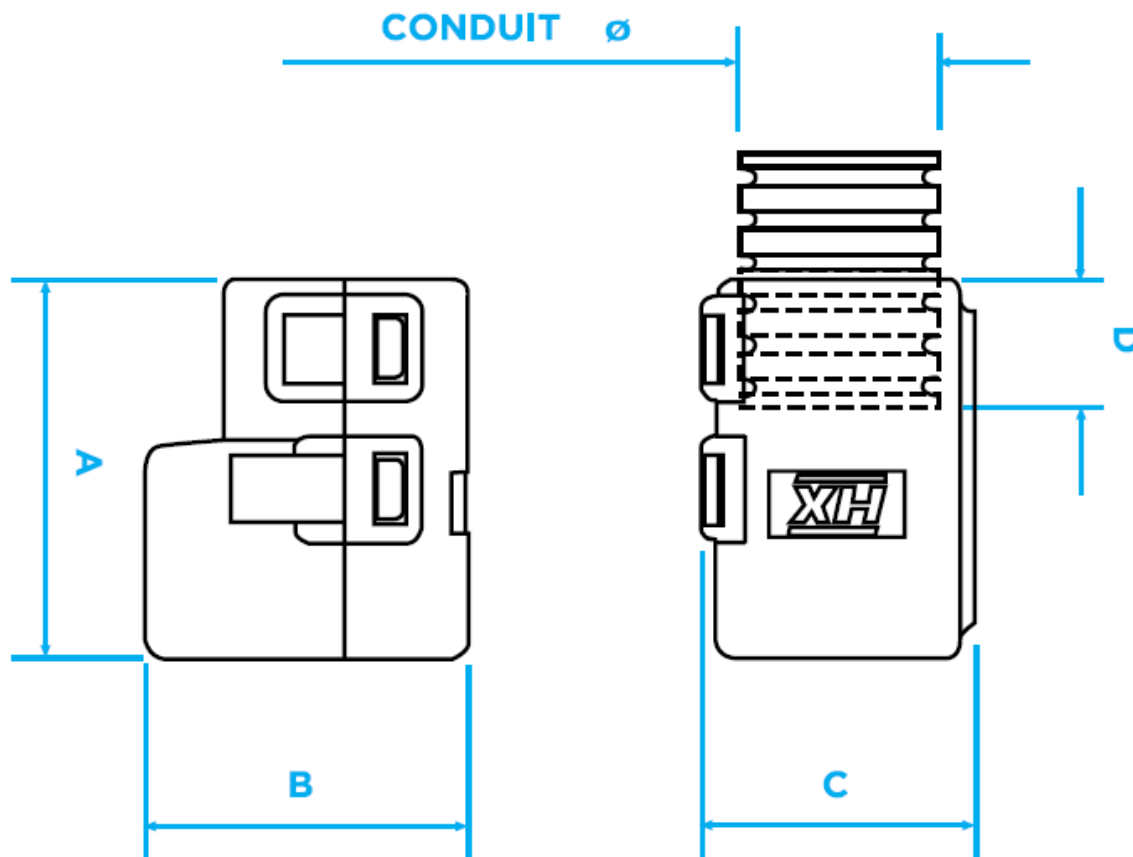

Conduit Systems - Interfaces



AMP Junior & Mini Hinged Connector Interface

SPECIALIST CONDUIT SYSTEMS

Dimensional Data

Part No Swivel 90° Interface	Conduit Size		Dimensions				Connector Reference
	(NC)	(NW)	A	B	C	D	
CI08-90-AM2	08	7.5	35.7	30.3	21.3	7.0	AMP Junior timer 2-way
CI08-90-AM3	08	7.5	35.7	30.3	27.2	7.0	AMP Junior timer 3-way
CI08-90-AM4	08	7.5	39.5	30.3	32.0	7.0	AMP Junior timer 4-way
CI10-90-AM2	10	8.5	37.5	38.0	21.3	10.0	AMP Junior timer 2-way
CI10-90-AM3	10	8.5	37.5	38.0	27.2	10.0	AMP Junior timer 3-way
CI10-90-AM4	10	8.5	41.2	38.0	32.0	10.0	AMP Junior timer 4-way
CI12-90-AM2	12	10	35.7	30.3	21.3	7.0	AMP Junior timer 2-way
CI12-90-AM3	12	10	35.7	30.3	27.2	7.0	AMP Junior timer 3-way
CI12-90-AM4	12	10	39.5	30.3	32.0	7.0	AMP Junior timer 4-way

Part No Straight Interface	Conduit Size		Dimensions				Connector Reference
	(NC)	(NW)	A	B	C	D	
CI12-90-X01	12	10	37	30.3	19	10	AMP Mini timer 1-way

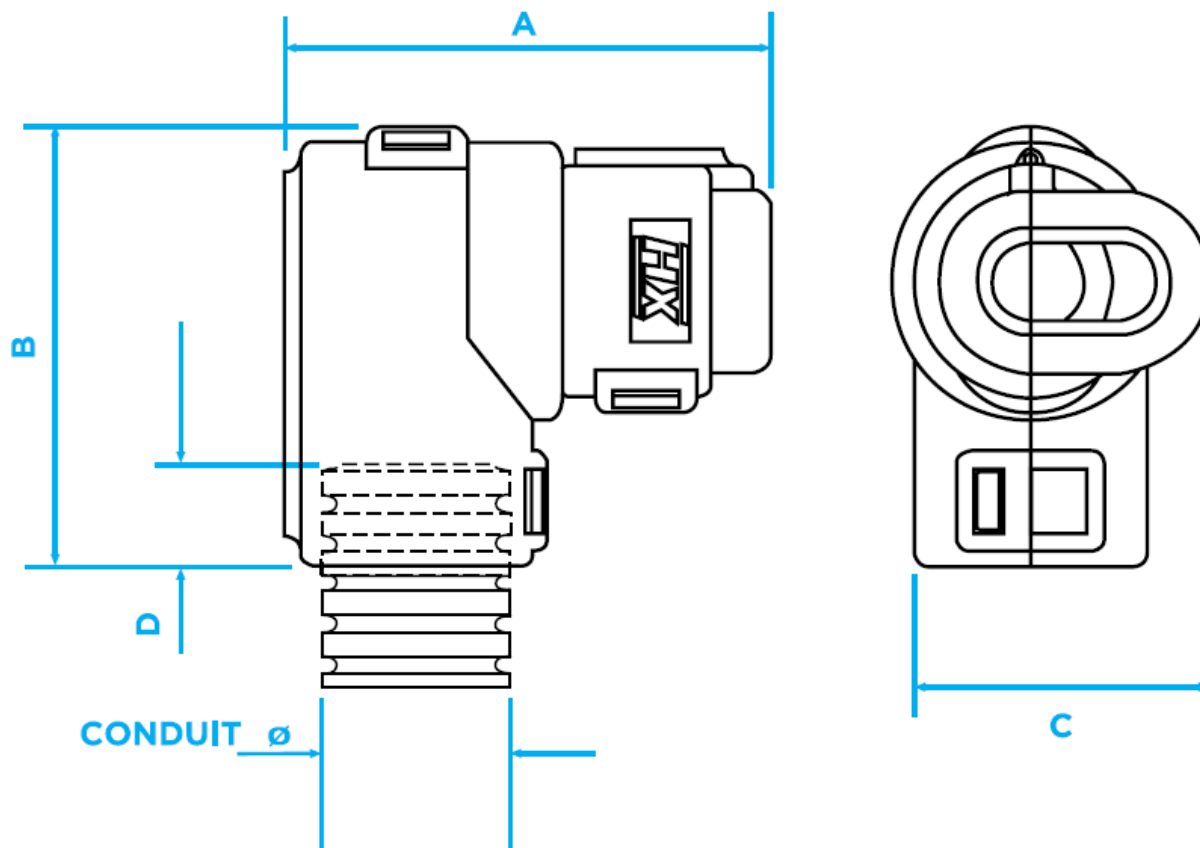































































Conduit Systems - Interfaces



AMP Junior & Mini Hinged Connector Interface

SPECIALIST CONDUIT SYSTEMS

Chemical Resistance Chart

Key: Suitable :  Limited Suitability :  Unsuitable :  Not Tested : 	 Astm No.1	 Diesel oil	 Methyl Bromide	 Sulphur Dioxide (Gas)
	 Astm No.2	 Diethylamine	 MEK	 Sulphuric Acid (10%)
	 Astm No.3	 Ethanol	 Nitric Acid (10%)	 Sulphuric Acid (70%)
	 Acetic Acid (10%)	 Ether	 Nitric Acid (70%)	 Toluene
	 Acetone	 Ethylamine	 Oxalic Acid	 Transformer Oil
	 Aluminium Chloride	 Ethylene Glycol	 Ozone (Gas)	 1,1,1-Trichloroethane
	 Aniline	 Ethyl Ethanoate	 Paraffin oil	 Trichloroethylene
	 Benzaldehyde	 Freon 32	 Petrol	 Turpentine
	 Benzene	 Hydrochloric Acid (10%)	 Phenol	 Vegetable Oil
	 Carbon tetrachloride	 Hydrochloric Acid (36%)	 Sea Water	 Vinyl Acetate
	 Chlorine water	 Hydrogen Peroxide (35%)	 Silver Nitrate	 Water
	 Chloroform	 Hydrogen Peroxide (87%)	 Skydrol	 White Spirit
	 Citric Acid	 Lactic Acid	 Sodium Chloride	 Zinc Chloride
	 Copper Sulphate	 Lubricating oil	 Sodium Hydroxide (10%)	
	 Cresol	 Methanol	 Sodium Hydroxide (60%)	

The information above is given as a guide only and is based on published technical data and experience. The chemical resistance of the above products is dependant on factors such as chemical exposure, concentration of the chemical and temperature. The above chemicals are valid for a temperature of 23°C. Use of the above table is at the users own discretion and risk. Those using it must satisfy themselves that their application presents no health and safety risks. The end user should assess compatibility with their application and contact Thomas & Betts for further information.

ADHERENCE TO THE CURRENT WIRING REGULATIONS BS7671 OR NEC WIRING REGULATIONS (FOR USA) IS STRONGLY ADVISED.

MINIMUM BEND RADIUS FOR FLEXING IS DEPENDANT UPON MINIMUM TEMPERATURE, BENDING FREQUENCY AND CHEMICAL ENVIRONMENT.

Storage Guidelines

To maintain balanced moisture content, Harnessflex recommends storing products under the following conditions:

Storage temp.	Installation temp.	Rel. humidity
18°C to 30°C	>18°C	>30%

If products from an outside environment are brought into a heated processing area, the change in climate may suddenly cause temporary de-moisturisation around the edges. After 24 hours in the processing area a natural balance will be restored.

Observing this storage recommendation ensures optimum process-ability and material properties.