

Conduit Systems - Fittings

Type CGS - Cable Glands



Technical Characteristics

Conforms to	CE Mark to the low voltage directive RoHS Compliant to 2011/65/EU Conforms with end of life vehicle directive (ELV) EU200/53/EC
-------------	---

Approvals and Standards	
-------------------------	--

Degree of mechanical protection	Medium
---------------------------------	--------

Degree of protection	IP68 - 5 bar 30 minutes ONLY
----------------------	------------------------------

UV protection	Very High (Black)
---------------	-------------------

Finish	Black (BL)
--------	------------

Application	Straight compression type cable glands IP68 5 bar (for 30 minutes only) incorporating fixed male threads to provide secure cable connections through knockouts and threaded entries.
-------------	--

Normal operating temperature range	Application	Min Temp	Max Temp
	Static	- 40°C	+120°C
	Dynamic	- 5°C	+120 °C

For use with - Conduit range	For use with all Conduits in the Harnessflex range
------------------------------	--

Fire performance	Test Standard	Performance Rating
	Not rated	Not rated

Self Extinguishing
Low smoke toxicity
& Halogen Free

Chemical resistance & Storage data	Click or See page 3
------------------------------------	-------------------------------------

Type of material	Polyamide (Nylon) PA 66 - heat and UV stabilised & Seal (TPE) Thermoplastic elastomer
------------------	--



Conduit Systems - Fittings

Type CGS - Cable Glands



Technical & Dimensional Data

Part Number	Thread	Cable O/D Range	Nominal dimensions (mm)			
	A	B	C	D	E	F
CGS-M16	M16x1.5	4.0 - 10.0	9	34.5	21	23.5
CGS-M20	M20x1.5	6.0 - 12.0	10	37	24	27
CGS-M25	M25x1.5	13.0 - 18.0	11	40	30	33
CGS-M32	M32x1.5	17.0 - 25.0	12	49	41	45.5
CGS-M40	M40x1.5	24.0 - 32.0	13	55	50	55.5
CGS-M50	M50x1.5	24.0 - 38.5	12	65	60	68
CGS-M63	M63x1.5	35.0 - 44.0	12	67	70	79
CGS-PG07	PG7	2.0 - 6.5	8	31	17	19
CGS-PG09	PG9	4.0 - 10.0	8	33.5	21	23.5
CGS-PG11	PG11	6.0 - 12.0	8	35	24	27
CGS-PG13	PG13.5	6.0 - 12.0	9	36	24	27
CGS-PG16	PG16	10.0 - 14.0	10	38.5	27	30
CGS-PG21	PG21	13.0 - 18.0	11	40	30	33
CGS-PG29	PG29	17.0 - 25.0	11	48	41	45.5
CGS-PG36	PG36	24.0 - 32.0	13	55	50	55.5

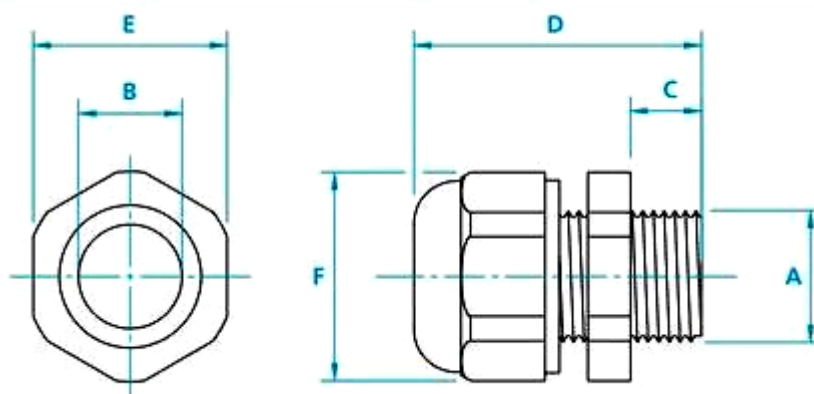































































Conduit Systems - Fittings

Type CGS - Cable Glands



Chemical Resistance Chart

Key: Suitable :  Limited Suitability :  Unsuitable :  Not Tested : 	 Astm No.1	 Diesel oil	 Methyl Bromide	 Sulphur Dioxide (Gas)
	 Astm No.2	 Diethylamine	 MEK	 Sulphuric Acid (10%)
	 Astm No.3	 Ethanol	 Nitric Acid (10%)	 Sulphuric Acid (70%)
	 Acetic Acid (10%)	 Ether	 Nitric Acid (70%)	 Toluene
	 Acetone	 Ethylamine	 Oxalic Acid	 Transformer Oil
	 Aluminium Chloride	 Ethylene Glycol	 Ozone (Gas)	 1,1,1-Trichloroethane
	 Aniline	 Ethyl Ethanoate	 Paraffin oil	 Trichloroethylene
	 Benzaldehyde	 Freon 32	 Petrol	 Turpentine
	 Benzene	 Hydrochloric Acid (10%)	 Phenol	 Vegetable Oil
	 Carbon tetrachloride	 Hydrochloric Acid (36%)	 Sea Water	 Vinyl Acetate
	 Chlorine water	 Hydrogen Peroxide (35%)	 Silver Nitrate	 Water
	 Chloroform	 Hydrogen Peroxide (87%)	 Skydrol	 White Spirit
	 Citric Acid	 Lactic Acid	 Sodium Chloride	 Zinc Chloride
	 Copper Sulphate	 Lubricating oil	 Sodium Hydroxide (10%)	
	 Cresol	 Methanol	 Sodium Hydroxide (60%)	

The information above is given as a guide only and is based on published technical data and experience. The chemical resistance of the above products is dependant on factors such as chemical exposure, concentration of the chemical and temperature. The above chemicals are valid for a temperature of 23°C. Use of the above table is at the users own discretion and risk. Those using it must satisfy themselves that their application presents no health and safety risks. The end user should assess compatibility with their application and contact Thomas & Betts for further information.

ADHERENCE TO THE CURRENT WIRING REGULATIONS BS7671 OR NEC WIRING REGULATIONS (FOR USA) IS STRONGLY ADVISED.

MINIMUM BEND RADIUS FOR FLEXING IS DEPENDANT UPON MINIMUM TEMPERATURE, BENDING FREQUENCY AND CHEMICAL ENVIRONMENT.

Storage Guidelines

To maintain balanced moisture content, Harnessflex recommends storing products under the following conditions:

Storage temp. 18°C to 30°C	Installation temp. >18°C	Rel. humidity >30%
--------------------------------------	------------------------------------	------------------------------

In the very dry winter months the moisture balance may go down slightly as the material releases moisture to the environment (owing to lower relative humidity).

Compared to natural outdoor conditions* at around 0°C (40 ... 80% rh), the humidity in heated rooms may drop by half to below 20% rh if no humidification is present. (Even extremely dry regions such as the Sahara Desert record average humidity of 20% to 60% rh.) (*Central European climate.)

If products from an outside environment are brought into a heated processing area, the change in climate may suddenly cause temporary de-moisturisation around the edges. After 24 hours in the processing area a natural balance will be restored.

Observing this storage recommendation ensures optimum process-ability and material properties.